

SAW BLADE	2	MISCELLANEOUS GRAPHICS	25
RACKS	2	
PRICING	3	HOLE SAWS	26
RACKS	4	PRO & IND HOLE SAWS	26
4 WING FLOOR RACKS :: PARTS	5	IND M42 COBALT HOLE SAWS	27
RACKS	6	
ECO-2-GO	7	ROUTER BITS	28
MISCELLANEOUS RACKS	8	RECIPS	29
PRICING HARDWARE	9	RECIPROCATING BLADES	29-30
MISCELLANEOUS HARDWARE	10	
HOLDER & HOOK	10	SCREWDRIVER BIT SPINNER & POP	31
HEADERS & GRAPHICS	11	MAGNETIC BIT & SCREW HOLDER	31
4 FOOT	11-12	TORSION BIT DISPLAY	32-33
CATEGORY HEADERS	13	TORSION BIT STICKERS	34-35
STARLOCK OTA	14	
PEGBOARD	15	SCREWDRIVER & IMPACT BIT SPINNERS	36-39
40TH ANNIVERSARY LIMITED EDITION	16	
DISPLAY BOX	16	BIN LABELS	40
HEADERS & GRAPHICS	17	CARABINER SPINNER	40
PEGBOARD	17-19	STICKERS	41
PEGBOARD HEADER	20-22	MISCELLANEOUS BIT DISPLAYS	42-44
CATEGORY HEADERS	23-24	
		ABRASIVES	45
		MISCELLANEOUS DISPLAYS	45
		
		CASHIER CARDS	46
		GUIDES & AIDS	46
		
		PRINTED COLLATERAL	47

3 & 4 Wing Floor



Single Wing Wall



All blade racking requires the addition of adhesive Price Channels and Price Tickets.



A	3RCK209	Price Channels, adhesive, pkg of 100
B	3STN420C	Price Tickets, paper, CANADIAN
	3STN420U	Price Tickets, paper, USw
C	3SGN800	Tape, Foam, Double-Sided, 1" x 1", roll of 650 squares *

Problems with Adhesion

Plastic price channels (**A**) have an adhesive backing strip. For them to stick well, they must be pressed down firmly onto a clean cardboard insert on the first application. Re-application once the channel has fallen off usually doesn't work. Still, several have found that the channels aren't sticking to some of their displays. If that's the case, please use the double-sided foam squares provided (**C**). We'll improve the adhesive strips on the next order.

* Item C will be available first part of January.

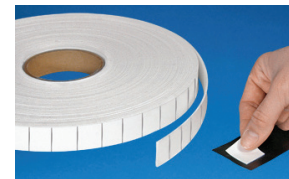

Price Channel Positioning

New cardboard inserts have markings to aid price channel positioning — align the bottom edge of the Price Channel with the white mark on the cardboard. For older displays, use the measurements below.

1. Leave 1/4" between top edge of Channel and top of Cardboard Insert
2. 8" down - bottom edge of Price Channel
3. 16" down - bottom edge of Price Channel
4. 25.5" - bottom edge of Price Channel
5. 35.5" - bottom edge of Price Channel
6. 45.5" - bottom edge of Price Channel



4-Wing Rotating Floor Rack

Rotating Floor Racks

Note:
If you require a complete rack, you must order both the rack and the signage kit.

3RCK050	Price Channels, adhesive, pkg of 100
Order the above rack and signage :	
3SGN050	Cardboard Inserts (set of 4 for 1 rack)
3POP051E	Signage Kit - includes: 1 Header w pins & clips, 4 side strips, 4 EAB new logo cover-up decals
3POP051F	Signage Kit - includes: 1 Header w pins & clips, 4 side strips, 4 EAB new logo cover-up decals



Circular Header
(w/ pins and clips)

Logo Cover-up Decal

3POP051E/F

Retrofit Signage Kits
These include POP and hardware (except Cardboard Inserts below) needed to convert existing racks to new branding. Order Cardboard Inserts separately.



Wing Side Strip Decals



Cardboard Inserts
New Cardboard Inserts (from July 2014 onwards) have the logo printed on them, so won't require the logo cover-up decals found in the above kits. These can be used for other purposes.

These new Inserts also have Price Channel position markings for easier set-up.

4 Wing Floor Racks: Parts <



A	3RCK054	Wire Header (floor rack)
B	3RCK052	Wing Only (6-peg)
C	3RCK053	4-Wing Barrel (floor rack)
D	3RCK064	Floor Stand (c/w bearing & washer)
E	3RCK057	4" Pole Extension
F	3RCK056	Security Bar
G	3RCK001	Washer
H	3RCK002	Bearing Ring
I	3RCK003	Cotter Pin
J	3RCK058	Small Blade Attachment
K	3RCK055	Brochure Holder
L	3RCK038	7/16" Locking Collars





Single Wing Swivel Wall Rack

Note:
If you require a complete rack, you must order the rack, the mounting parts and the signage.

If mounting to pegboard:
re-inforce the pegboard to support the weight.

D

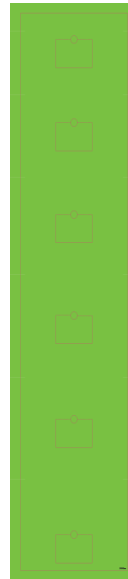

E



These side strips also work for floor racks

A



B



F



G



H



Exchange System & Blade Guide wall-mount graphics. Multi-purpose. Can be mounted between wings.

7" x 21" ea.

A 3RCK052 Single Wing Only (mounting parts separate)

To instal 1 single wing onto pegboard, order 1 of:

A 3RCK049 Single Wing Swivel Wall Mounts (complete set)

To instal 1 single wing onto plywood, order 2 of:

C 3RCK607 Mounting Bar (Single Wing) - 3 slots
3RCK608 Mounting Bar (Single Wing) - 2 slots

C



D 3POP052 Price Channels, adhesive, pkg of 100

E 3SGN052E Price Tickets, paper, CANADIAN

3SGN052F Price Tickets, paper, US

F 3SGN181E Header - single wing rack - English

3SGN181F Header - single wing rack - French

G 3RCK259 Wire Sign Holder (2 required)

H 3SGN008E Blade Guide btwn Wings (2 pcs) - English

3SGN008F Blade Guide btwn Wings (2 pcs) - French

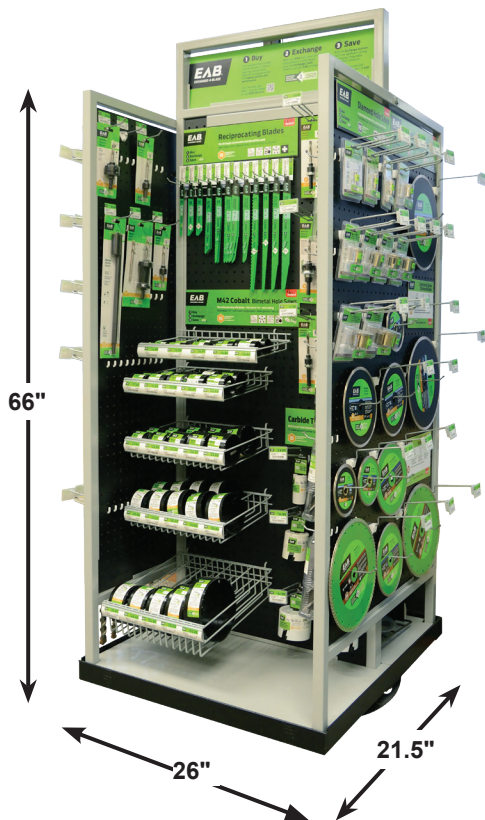

3RCK615	Eco-2-Go Rack (2')
3RCK616	Eco-2-Go Spinner Attachment

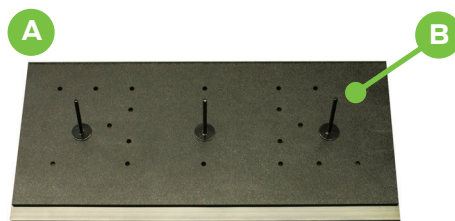

Blade Rack for ECO-2-GO

A	3RCK012	ABS Blade Rack (24"W x 12"H) Includes 2 hanger brackets. Does not include pegs - order below.
B	3RCK011	Pegs for 3RCK012 (above), 1 each

1 Buy

Our complete line of power tool accessories is made to exacting specifications. Rigorous testing guarantees the highest quality and performance.

Don't see what you need — ask your dealer or visit EABTool.com.

2 Exchange

When your EAB tool is worn or dull, simply return it to your dealer. Apply the **Exchange Credit** towards your next EAB purchase.

3 Save

With the **Exchange System**, you'll see significant savings over buying comparable competitors' products.

Compare for yourself and discover all the benefits of EAB.

eco

1 Achetez

Tous nos accessoires d'outils électriques sont fabriqués selon les normes les plus strictes et sont soumis à des tests rigoureux. Cela vous garantit la plus haute qualité et performance.

Vous ne trouvez pas ce que vous avez besoin — demandez à votre marchand ou visitez EABTool.com.

2 Échangez

Lorsque votre accessoire d'outil EAB est émoussé, retournez-le chez votre marchand. Appliquez le **Credit d'Échange** vers votre prochain achat EAB.

3 Économisez

Une fois dans le **Système d'Échange**, vous économisez un montant considérable à comparer aux produits de nos concurrents.

Comparez pour vous-même et découvrez les avantages EAB.

eco

EAB
EXCHANGE-A-BLADE

Power Tool Accessories

tested

1 Buy

Select the perfect power tool accessory from over 500 exchangeable high performance power tool accessories.

2 Exchange

When it's dull and ready to be replaced, simply return it to your retail store, and apply the credit towards a new one.

3 Save

With the green exchange system, you'll see significant savings over buying comparable competitors' products.

Don't see what you need — ask your dealer or visit EABTool.com.

eco

	3SGN616E	22" x 6" Eco2-Go Header, double-sided En/En
C	3SGN616F	22" x 6" Eco2-Go Header, double-sided Fr/Fr
	3SGN618E	22" x 6" Eco2-Go Header, double-sided En/En

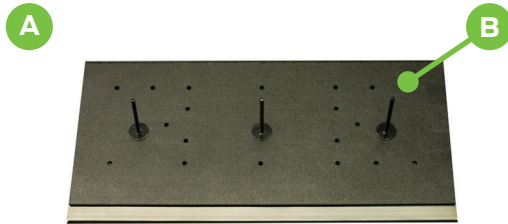

For flat wall or ECO-2-GO

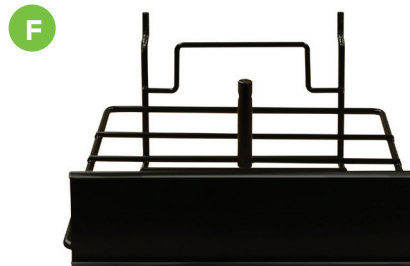
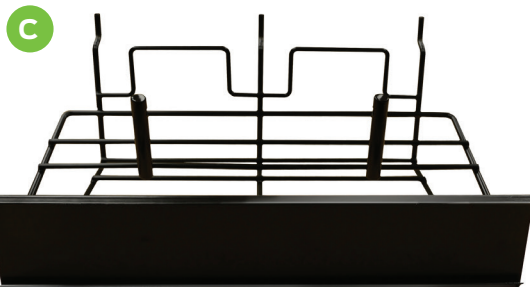
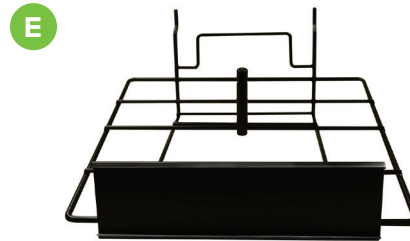

A	3RCK012	ABS Blade Rack (23 3/4"W x 12"H) Includes 2 hanger brackets. Does not include pegs - order below. Fits the Eco-2-Go
B	3RCK011	Pegs for 3RCK012 (above), 1 each
C	3RCK019	Wall Platform SM (2 peg)
D	3RCK021	Wall Platform MED (3 peg)
E	3RCK022	Wall Platform MED 10"(1 peg)
F	3RCK020	Wall Platform MED (1 peg)
G	3RCK023	Wall Platform MED 12"(1 peg)

For POP please see page 14-20

Depending on their design, your existing double-loop hooks will require either : (B) & (C) or (I) & (J) components. This will cover the vast majority of hanging product. Some small packaged items, and blades displayed on peg wall (e.g. diamond blades), may require some of the other single hook hardware below.

Current design Southern Imperial hooks

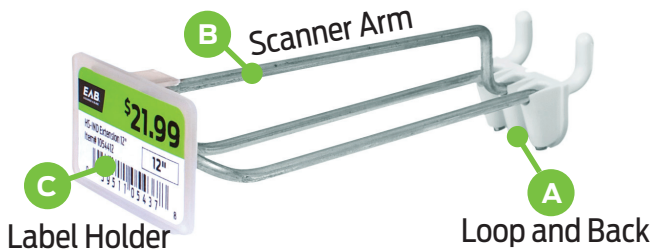

Older design Trion hooks

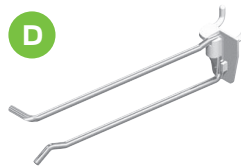
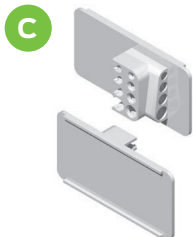
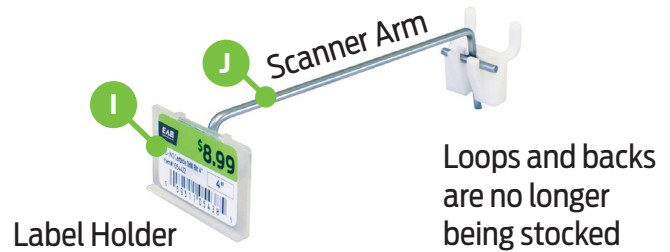

*Required for 4-flute Auger Bits

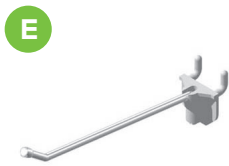

GONDOLA

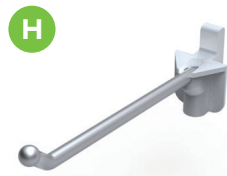

A	3RCK119	Loop Hook, 4" with back, pkg 100.
B	3RCK328	Scan Arm, 4", pkg 100. Attaches to 3RCK119 (A).
C	3RCK329	Label Holder, 2" x 1.25", pkg 100. Attaches to 3RCK328 (B), 3RCK333 (D) and 3RCK332 (F).
D	3RCK333	Single Arm Hook w Scan Arm, 4", pkg 100. For small items that can't be hung with butterfly hooks. Use with 3RCK329 (C). These slightly longer hooks are needed for our new 4-Flute Auger Bits, to hold the larger sizes.
E	3RCK121	Single 2½" Ball Hooks for peg board, pkg 100. In the case of items such as hanging Diamond Blades, you'll need 3RCK332 (F) to display pricing next to the product.
F	3RCK332	Single Scan Arm, 4", pkg 100. For items that need pricing added next to the product, such as Diamond Blades using single ball hooks. Use with 3RCK329 (C).
G	3RCK448	Gondola Upright Stem Hook, 8", w Scanner Arm, order individually. Use with 3RCK329 (C).
H	3RCK457	Gondola Upright Single 4" Ball Hook, order individually (this is not a new item).
I	3RCK334	Scan Arm, 4", pkg 100. Attaches to older loop hooks as illustrated.
J	3RCK335	Label Holder, 2" x 1.25", pkg 100. Attaches to 3RCK334 (I).

Holder & Hook <



A	3RCK325	Christmas Tree Plugs
B	3RCK326	Plastic Push Pin
C	3RCK055A	Screw kit for brochure holder (for mounting on plywood)
D	3RCK267	Lock (Optional)
E	3RCK324	Merchandising strip (Holds 12 items) (order in 20s)
F	3RCK254	30" Strong merchandising strip (Holds 12 items)
G	3RCK258	Hang Tabs
H	3RCK256	Plastic Wobbler with Spring
I	3RCK255	Plastic Wobbler
J	3RCK130	Flexible Sign Holder (for verticle headers)
K	3RCK257	T Sign Holder
L	3RCK259	Wire Sign Holder (for wire racks)
M	3RCK260	Ridgid Sign Holder
N	3RCK320	4" Black Plastic Hook, pkg 100
O	3RCK321	6" Black Plastic Hook, pkg 100
P	3RCK322	8" Black Plastic Hook, pkg 100



EAB
EXCHANGE-A-BLADE

EABTool.com

1 Buy
Our complete line of power tool accessories is made to exacting specifications. Rigorous testing guarantees the **highest quality and performance.**

2 Exchange
When your **EAB** tool is worn or dull, simply return it to your dealer and apply the **Exchange Credit** towards your next **EAB** purchase.

3 Save
With the **Exchange System** you'll see significant savings over buying comparable competitors' products. Compare for yourself and discover all the benefits of **EAB**.

IND INDUSTRIAL QUALITY
EXTREME-DUTY

PRO PROFESSIONAL QUALITY
HEAVY-DUTY

GEN GENERAL QUALITY
CONTRACTOR & DIY USE



3SGN612E - 4' x 7" Section Header - EAB #123, styrene, En



EAB
EXCHANGE-A-BLADE

EABTool.com

1 Achetez
Tous nos accessoires d'outils électriques sont fabriqués selon les normes les plus strictes et sont soumis à des tests rigoureux. Cela vous garantit la **plus haute qualité et performance.**



2 Échangez
Lorsque votre accessoire d'outil **EAB** est émoussé, retournez-le chez votre marchand. Appliquez le **Crédit d'échange** vers votre prochain achat **EAB**.

3 Économisez
Une fois dans le **Système d'Échange**, vous économiserez un montant considérable à comparer aux produits de nos compétiteurs. Comparez pour vous-même et découvrez les avantages **EAB**.

IND QUALITÉ INDUSTRIELLE
TRAVAUX INTENSIFS

PRO QUALITÉ PROFESSIONNELLE
TRAVAUX LOURDS

GEN QUALITÉ GÉNÉRALE
CONTRACTEUR & BRICOLAGE

3SGN612F - 4' x 7" Section Header - EAB #123, styrene, Fr



EAB
EXCHANGE-A-BLADE

EABTool.com

Power Tool Accessories



GEN GENERAL QUALITY
CONTRACTOR & DIY USE

PRO PROFESSIONAL QUALITY
HEAVY-DUTY

IND INDUSTRIAL QUALITY
EXTREME-DUTY

1 Buy
2 Exchange
3 Save



3SGN613E - 4' x 7" Section Header - EAB PTA, styrene, En



EAB
EXCHANGE-A-BLADE

EABTool.com

Accessoires d'outils électriques



GEN QUALITÉ GÉNÉRALE
CONTRACTEUR & BRICOLAGE

PRO QUALITÉ PROFESSIONNELLE
TRAVAUX LOURDS

IND QUALITÉ INDUSTRIELLE
TRAVAUX INTENSIFS

1 Achetez
2 Échangez
3 Économisez



3SGN613F - 4' x 7" Section Header - EAB PTA, styrene, Fr

Category Headers



EAB
EXCHANGE-A-BLADE

EABTool.com

Bimetal Hole Saws



50 cuts in 3/16" steel tubing vs. competitors' 20-40
M2 High Speed Steel • 4/6 tooth configuration • 1 3/8" depth

PRO PROFESSIONAL QUALITY
HEAVY-DUTY





1 Buy
2 Exchange
3 Save





EAB
EXCHANGE-A-BLADE

EABTool.com

Scies Emporte-Pièces Bimétal



50 coupes dans les tubes en acier 3/16" vs 20 à 40 pour les concurrents
Acier rapide M2 • Configuration 4/6 variable des dents • Profondeur de 1 3/8"

PRO QUALITÉ PROFESSIONNELLE
TRAVAUX LOURDS





1 Achetez
2 Échangez
3 Économisez



3SGN081E & 3SGN081F - EAB PRO Bimetal HS, 12" x 4"

With only a couple exceptions, all headers are now single-sided - either English or French.

4 foot <

EAB
EXCHANGE-A-BLADE

Bimetal Hole Saws

80 cuts in 3/16" steel tubing vs. competitors' 20-50
M3 High Speed Steel • 4/6 tooth configuration • 1 3/4" depth

1 Buy
2 Exchange
3 Save **eco**

IND INDUSTRIAL QUALITY EXTREME-DUTY

tested

EAB
EXCHANGE-A-BLADE

Scies Emporte-Pièces Bimétal

80 coupes dans les tubes en acier 3/16" vs 20 à 50 pour les concurrents
Acier rapide M3 • Configuration 4/6 variable des dents • Profondeur de 1 3/4"

1 Achetez
2 Échangez
3 Économisez **eco**

IND QUALITÉ INDUSTRIELLE TRAVAUX INTENSIFS

tested

3POPO45E & 3POPO45F - EAB IND Bimetal HS, 12" x 4"

EAB
EXCHANGE-A-BLADE

Carbide Tipped Hole Saws

10X Faster than bimetal saws • Over 870 cuts in 2 1/2" Hardieplank®
C2 triple-ground carbide teeth • 2 1/2" depth • easy plug removal

1 Buy
2 Exchange
3 Save **eco**

IND INDUSTRIAL QUALITY EXTREME-DUTY

10x

For fiber cement use with EAB Carbide Pilot Drill

tested

EAB
EXCHANGE-A-BLADE

Scies Emporte-Pièces au Carbone

10X plus rapide qu'une scie emporte-pièce bimétal
Plus de 870 coupes dans le Hardieplank® 2 1/2"
Affûtage complet • Profondeur de 2 1/2" • Retire facilement les copeaux

1 Achetez
2 Échangez
3 Économisez **eco**

IND QUALITÉ INDUSTRIELLE TRAVAUX INTENSIFS

10x

Pour le fibrociment, utilisez avec forêt de recharge à pointe de carbure

tested

3POPO48E & 3POPO48F - EAB IND Carbide HS, 12" x 4"

EAB
EXCHANGE-A-BLADE

Diamond Hole Saws

Long lasting diamonds for fast, precise, chip-free cuts
For handheld or press drills • Must be used with water

1 Buy
2 Exchange
3 Save **eco**

GEN GENERAL QUALITY CONTRACTOR & DIY USE

tested

EAB
EXCHANGE-A-BLADE

Scies Emporte-Pièces Diamantés

Diamants durables pour des coupes rapides et précises sans fragments
Pour perceuses à main ou à colonne • Doit être utilisé avec de l'eau

1 Achetez
2 Échangez
3 Économisez **eco**

GEN QUALITÉ GÉNÉRALE CONTRACTEUR & BRICOLAGE

tested

3SGN371E & 3SGN371F - EAB GEN Diamond HS, 12" x 4"

EAB
EXCHANGE-A-BLADE

4 Flute Wood Augers

Four cutting spurs for faster cleaner bores in all types of wood
1/4" quick-change shank • Self-feeding screw point • 4" depth

1 Buy
2 Exchange
3 Save **eco**

GEN GENERAL QUALITY CONTRACTOR & DIY USE

X4

ULTRA-FAST

tested

EAB
EXCHANGE-A-BLADE

Mèches Tarière à Bois

4 tranchants pour percer plus nettement et rapidement à travers le bois
Tige 1/4" à changement rapide • Compatible avec les outils à percussion
Pointe à filets • Profondeur de 4"

1 Achetez
2 Échangez
3 Économisez **eco**

GEN QUALITÉ GÉNÉRALE CONTRACTEUR & BRICOLAGE

X4

ULTRA-RAPIDE

tested

3SGN073E & 3SGN073F - EAB GEN 4 Flute Wood Auger, 12" x 4"

EAB
EXCHANGE-A-BLADE

M42 Cobalt Bimetal Hole Saws

The ultimate long-life blade • 140 cuts in 3/16" steel tubing
Extra deep 1 7/8" • 4/6 tooth configuration • flean ground • easy plug removal

1 Buy
2 Exchange
3 Save **eco**

IND INDUSTRIAL QUALITY EXTREME-DUTY

tested

EAB
EXCHANGE-A-BLADE

Cobalt M42 Scies Emporte-Pièces Bimétal

La lame longue vie ultime • 140 coupes dans les tubes en acier 3/16"
Corps extra long 1 7/8" • Configuration 4/6 variable des dents • Retire facilement les copeaux

1 Achetez
2 Échangez
3 Économisez **eco**

IND QUALITÉ INDUSTRIELLE TRAVAUX INTENSIFS

tested

3POPO83E & 3POPO83F - EAB IND M42 HS, 14" x 4"

EAB
EXCHANGE-A-BLADE

Oscillating Tool Accessories

Cut it. Scrape it. Sand it. Grind it. Remove it.
Fast, precision made tools designed to fit most major brands

1 Buy
2 Exchange
3 Save **eco**

PRO PROFESSIONAL QUALITY HEAVY-DUTY

tested

EAB
EXCHANGE-A-BLADE

Accessoires d'Outils Oscillants

Coupez, meulez, raclez et sablez
Accessoires de précision pour outils oscillants

1 Achetez
2 Échangez
3 Économisez **eco**

PRO QUALITÉ PROFESSIONNELLE TRAVAUX LOUDRES

tested

3SGN145E & 3SGN145F - EAB/SS Double-sided, PRO SDS Bits, , 12" x 4"

With only a couple exceptions, all headers are now single-sided - either English or French.

EAB
EXCHANGE-A-BLADE

SDS Masonry Bits

Extra long life Carbide tips resist heavy loading
Unique flute design for improved material removal and speed
Precision fit on all rotary hammers

1 Buy
2 Exchange
3 Save **eco**

PRO PROFESSIONAL QUALITY HEAVY-DUTY

tested

EAB
EXCHANGE-A-BLADE

Mèches de type SDS

Pointes de carbure longue vie et résistantes aux charges extrêmes
Design unique de la goujure améliore le dégrossissage et réduit l'usure
S'adapte à tous les marteaux rotatifs de type SDS

1 Achetez
2 Échangez
3 Économisez **eco**

PRO QUALITÉ PROFESSIONNELLE TRAVAUX LOURDS

testé

3SGN142E & 3SGN142F - EAB/SS Double-sided, PRO SDS Bits, 12" x 4"

EAB
EXCHANGE-A-BLADE

Router Bits

Ultra fine results in wood, laminates and composites
Tungsten carbide cutters • 50+ profiles • 1/4" & 1/2" shanks • Enclosed bearings

1 Buy
2 Exchange
3 Save **eco**

PRO PROFESSIONAL QUALITY HEAVY-DUTY

tested

EAB
EXCHANGE-A-BLADE

Mèches de Toupie

Finition ultra fine du bois, stratifié et composite
Tranchants en carbure de tungstène • 50+ profils • Tiges 1/4" & 1/2" • Roulements étanches

1 Achetez
2 Échangez
3 Économisez **eco**

PRO QUALITÉ PROFESSIONNELLE TRAVAUX LOURDS

testé

3SGN118E & 3SGN118F - EAB PRO Router Bits, 14" x 4"

EAB
EXCHANGE-A-BLADE

Router Bits

Ultra fine results in wood, laminates and composites
Tungsten carbide cutters • 50+ profiles • 1/4" & 1/2" shanks • Enclosed bearings

1 Buy
2 Exchange
3 Save **eco**

IND INDUSTRIAL QUALITY EXTREME-DUTY

tested

EAB
EXCHANGE-A-BLADE

Mèches de Toupie

Finition ultra fine du bois, stratifié et composite
Tranchants en carbure de tungstène • 50+ profils • Tiges 1/4" & 1/2" • Roulements étanches

1 Achetez
2 Échangez
3 Économisez **eco**

IND QUALITÉ INDUSTRIELLE TRAVAUX INTENSIFS

testé

3SGN119E & 3SGN119F - EAB IND Router Bits, 14" x 4"

EAB
EXCHANGE-A-BLADE

Oscillating Tool Accessories

Cut it. Scrape it. Sand it. Grind it. Remove it.
High-grade Swiss steel for ultimate speed and durability • Designed to fit most major brands

1 Buy
2 Exchange
3 Save **eco**

IND INDUSTRIAL QUALITY EXTREME-DUTY

OIS

tested

EAB
EXCHANGE-A-BLADE

Accessoires d'Outils Oscillants

Coupez, meulez, raclez et sablez
Acier spécial et fabrication Suisse pour durabilité et vitesse ultime

1 Achetez
2 Échangez
3 Économisez **eco**

IND QUALITÉ INDUSTRIELLE TRAVAUX INTENSIFS

OIS

tested

3SGN148E & 3SGN148F - EAB IND OTA, 14" x 4"

EAB
EXCHANGE-A-BLADE

Diamond Blades

The right blade for every job: Segmented • Turbo • Continuous
Wet or dry cutting* • High diamond concentration • Long life

1 Buy
2 Exchange
3 Save

GEN GENERAL QUALITY CONTRACTOR & DIY USE

IND INDUSTRIAL QUALITY EXTREME-DUTY

tested

EAB
EXCHANGE-A-BLADE

Lames Diamantées

Une lame pour chaque tâche : Segmentée • Turbo • Continue
Coupe à sec ou à l'eau* • Haute concentration de diamants • Longue vie

1 Achetez
2 Échangez
3 Économisez

GEN QUALITÉ GÉNÉRALE CONTRACTEUR & BRICOLAGE

IND QUALITÉ INDUSTRIELLE TRAVAUX INTENSIFS

tested

3SGN368E & 3SGN368F - EAB GEN & IND Diamond Saws, 14" x 4"

EAB
EXCHANGE-A-BLADE

Reciprocating Blades

For all tough construction and demolition work
High Speed Steel • Bimetal teeth • Fits all reciprocating saws

1 Buy
2 Exchange
3 Save **eco**

IND INDUSTRIAL QUALITY EXTREME-DUTY

tested

EAB
EXCHANGE-A-BLADE

Lames pour Scie Alternative

Pour les travaux de construction et démolition intenses
Acier Rapide • Dents bimétalliques • S'adaptent à toutes scies alternatives

1 Achetez
2 Échangez
3 Économisez **eco**

IND QUALITÉ INDUSTRIELLE TRAVAUX INTENSIFS

tested

3SGN133E & 3SGN133F - EAB IND EAB Recips, 14" x 4"

EAB
EXCHANGE-A-BLADE

Razor Back Granite Hammer Drill Bit

Diamond ground carbide tip for taking on the toughest materials
Granite • Concrete • Masonry • Paving stones

1 Buy
2 Exchange
3 Save **eco**

IND INDUSTRIAL QUALITY EXTREME-DUTY

RAZOR

tested

EAB
EXCHANGE-A-BLADE

Razor Back Foret pour marteau perforateur

Dont de carbure diamanté pour attaquer les matériaux les plus coriaces
Granite • Béton • Maçonnerie • Pavés

1 Achetez
2 Échangez
3 Économisez **eco**

IND QUALITÉ INDUSTRIELLE TRAVAUX INTENSIFS

RAZOR

tested

NEW 3SGN143E & 3SGN143F - Double sided EAB IND, 14" x 4"

NEW



EAB EXCHANGE-A-BLADE

STARLOCK
Oscillating Tool Accessories
Cut it. Scrape it. Sand it. Grind it. Remove it.
High-grade Swiss steel for ultimate speed and durability

1 Buy
2 Exchange
3 Save **eco**

IND INDUSTRIAL QUALITY EXTREME-DUTY

Wood/Metal Wood Metal & More 4th Motion Coat & Abrasive

View our Fit Guide www.exchangeablade.com/resources/fit-guide/

EAB EXCHANGE-A-BLADE

STARLOCK
Accessoires d'Outils Oscillants
Coupez, meulez, raclez et sablez
Acier spécial et fabrication Suisse pour durabilité et vitesse ultime

1 Achetez
2 Échangez
3 Économisez **eco**

IND QUALITÉ INDUSTRIELLE TRAVAILX INTENSIFS

Bois/Métal Bits Métal & Plus Meubles souples Coat & Abrasifs

Se référer au Guide www.exchangeablade.com/resources/fit-guide/

3SGN374E & 3SGN374F - Starlock IND OTA, 14" x 4"

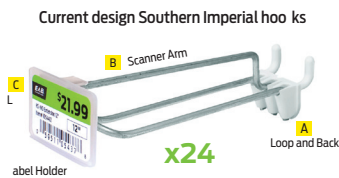

A3	3RCK119	Loop Hook, 4" with back, pkg 100.
B3	3RCK328	Scan Arm, 4", pkg 100. Attaches to 3RCK119 (A).
C3	RCK329	Label Holder, 2" x 1.25", pkg 100.

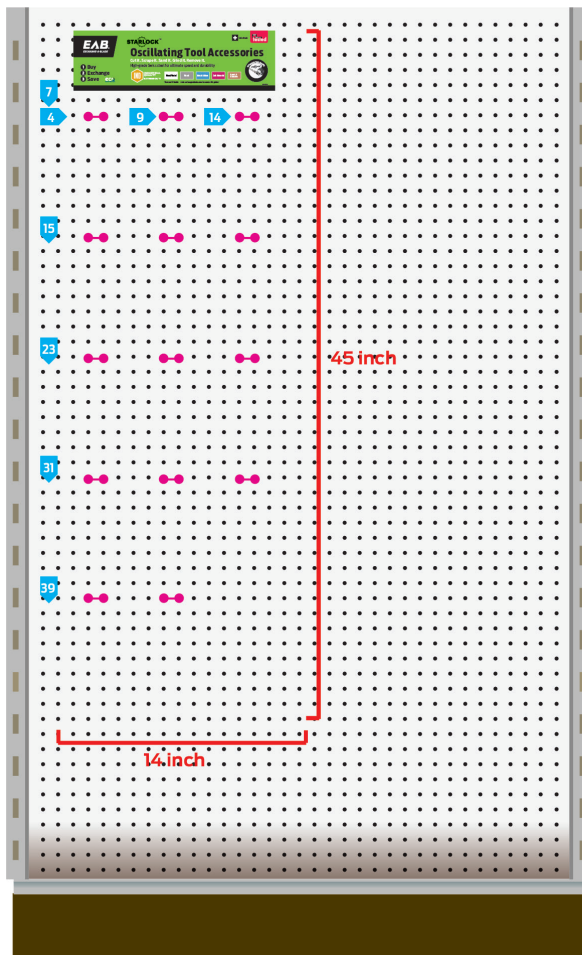

Pegboard



A

B

C

D

- A Category Pegboard - Header (8in x 5in)
- B Clear Size Stickers
- C Category Pegboard - Bottom
- D Price Sticker (Coming soon)

Clear Size Sticker (Pack)

9" x 50T	7 1/4" x 35T
9" x 40T	7 1/4" x 32T
9" x 24T	7 1/4" x 32T
7 1/4" x 150T	7 1/4" x 24T
7 1/4" x 150T	7 1/4" x 24T
7 1/4" x 100T	7 1/4" x 24T
7 1/4" x 75T	7 1/4" x 20T
7 1/4" x 72T	7 1/4" x 18T
7 1/4" x 60T	7 1/4" x 6T
7 1/4" x 50T	7 1/4" x 4T
7 1/4" x 50T	6 1/2" x 60T
7 1/4" x 48T	6 1/2" x 36T
7 1/4" x 40T	6 1/2" x 24T
7 1/4" x 40T	6 1/2" x 16T
7 1/4" x 40T	6 1/2" x 4T
7 1/4" x 40T	

Price Sticker



Order by Pack

3POP210E	Clear Size Sticker (Pack) for Pegboard English
3POP210F	Clear Size Sticker (Pack) for Pegboard French

* For racking please see page 8



FRONT VIEW



SIDE VIEW

3ADV080 40th Anniversary Box



3SGN810BE	EAB BL General Decking Pegboard Bottom - English
3SGN810BF	EAB BL General Decking Pegboard Bottom - French



3SGN811BE	EAB BL General Shelving Pegboard Bottom - English
3SGN811BF	EAB BL General Shelving Pegboard Bottom - French



3SGN812BE	EAB BL General Green Framing/Decking Pegboard Bottom - English
3SGN812BF	EAB BL General Green Framing/Decking Pegboard Bottom - French



3SGN813BE	EAB BL General Green Finishing Pegboard Bottom - English
3SGN813BF	EAB BL General Green Finishing Pegboard Bottom - French



3SGN814BE	EAB BL General Chop Saw Miter Pegboard Bottom - English
3SGN814BF	EAB BL General Chop Saw Miter Pegboard Bottom - French



3SGN815BE	EAB BL General Ultra Thin Pegboard Bottom - English
3SGN815BF	EAB BL General Ultra Thin Pegboard Bottom - French



3SGN816BE	EAB BL General All Purpose Pegboard Bottom - English
3SGN816BF	EAB BL General All Purpose Pegboard Bottom - French



3SGN817BE	EAB BL General Plywood Pegboard Bottom - English
3SGN817BF	EAB BL General Plywood Pegboard Bottom - French



3SGN818BE	EAB BL General Panelling Pegboard Bottom - English
3SGN818BF	EAB BL General Panelling Pegboard Bottom - French



3SGN819BE	EAB BL General Steel Sheeting Pegboard Bottom - English
3SGN819BF	EAB BL General Steel Sheeting Pegboard Bottom - French



3SGN831BE	EAB DB General Masonry Segmented Pegboard Bottom - English
3SGN831BF	EAB DB General Masonry Segmented Pegboard Bottom - French



3SGN832BE	EAB DB General Tile & Marble Pegboard Bottom - English
3SGN832BF	EAB DB General Tile & Marble Pegboard Bottom - French



3SGN833BE	EAB DB General Glass Pegboard Bottom - English
3SGN833BF	EAB DB General Glass Pegboard Bottom - French

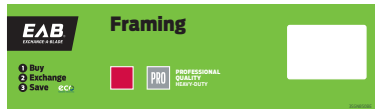

3SGN850BE EAB BL Professional Framing Pegboard Bottom - English

3SGN850BF EAB BL Professional Framing Pegboard Bottom - French



3SGN851BE EAB BL Professional Cabinetry Pegboard Bottom - English

3SGN851BF EAB BL Professional Cabinetry Pegboard Bottom - French



3SGN852BE EAB BL Professional Ultra Thin Pegboard Bottom - English

3SGN852BF EAB BL Professional Ultra Thin Pegboard Bottom - French

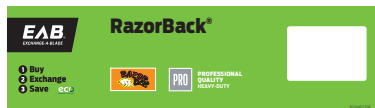

3SGN853BE EAB BL Professional Razor Back Pegboard Bottom - English

3SGN853BF EAB BL Professional Razor Back Pegboard Bottom - French



3SGN854BE EAB BL Professional Melamine & Laminates Pegboard Bottom - English

3SGN854BF EAB BL Professional Melamine & Laminates Pegboard Bottom - French



3SGN855BE EAB BL Professional All Purpose Pegboard Bottom - English

3SGN855BF EAB BL Professional All Purpose Pegboard Bottom - French



3SGN856BE EAB BL Professional Metal Pegboard Bottom - English

3SGN856BF EAB BL Professional Metal Pegboard Bottom - French



3SGN857BE EAB BL Professional Miter Wood Pegboard Bottom - English

3SGN857BF EAB BL Professional Miter Wood Pegboard Bottom - French



3SGN858BE EAB BL Professional Miter Aluminum Pegboard Bottom - English

3SGN858BF EAB BL Professional Miter Aluminum Pegboard Bottom - French



3SGN859BE EAB BL Professional Fiber Cement Pegboard Bottom - English

3SGN859BF EAB BL Professional Fiber Cement Pegboard Bottom - French



3SGN860BE EAB BL Professional Razor Tooth Finishing Pegboard Bottom - English

3SGN860BF EAB BL Professional Razor Tooth Finishing Pegboard Bottom - French



3SGN871BE EAB BL Industrial Cabinetry Pegboard Bottom - English

3SGN871BF EAB BL Industrial Cabinetry Pegboard Bottom - French

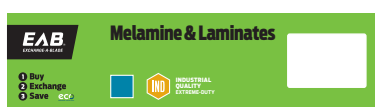

3SGN872BE EAB BL Industrial Melamine & Laminates Pegboard Bottom - English

3SGN872BF EAB BL Industrial Melamine & Laminates Pegboard Bottom - French



3SGN873BE EAB BL Industrial All Purpose Pegboard Bottom - English

3SGN873BF EAB BL Industrial All Purpose Pegboard Bottom - French



3SGN874BE EAB BL Industrial Miter Wood Pegboard Bottom - English

3SGN874BF EAB BL Industrial Miter Wood Pegboard Bottom - French



3SGN875BE EAB BL Industrial Miter Aluminum Pegboard Bottom - English

3SGN875BF EAB BL Industrial Miter Aluminum Pegboard Bottom - French



3SGN876BE EAB BL Industrial Metal Pegboard Bottom - English

3SGN876BF EAB BL Industrial Metal Pegboard Bottom - French



3SGN878BE EAB BL Industrial Fiber Cement Pegboard Bottom - English

3SGN878BF EAB BL Industrial Fiber Cement Pegboard Bottom - French



3SGN879BE EAB BL Industrial Razor Tooth Finishing Pegboard Bottom - English

3SGN879BF EAB BL Industrial Razor Tooth Finishing Pegboard Bottom - French



3SGN880BE EAB BL Industrial Laser Finishing Pegboard Bottom - English

3SGN880BF EAB BL Industrial Laser Finishing Pegboard Bottom - French



3SGN890BE EAB DB Industrial Porcelain Pegboard Bottom - English

3SGN890BF EAB DB Industrial Porcelain Pegboard Bottom - French



3SGN891BE EAB DB Industrial Masonry Turbo Pegboard Bottom - English

3SGN891BF EAB DB Industrial Masonry Turbo Pegboard Bottom - French



3SGN892BE EAB DB Industrial Tile & Marble Pegboard Bottom - English

3SGN892BF EAB DB Industrial Tile & Marble Pegboard Bottom - French

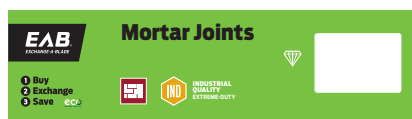

3SGN893BE EAB DB Industrial Mortar Joints Pegboard Bottom - English

3SGN893BF EAB DB Industrial Mortar Joints Pegboard Bottom - French

A **EAB** EXCHANGE-A-BLADE **Quality**

GEN **PRO** **IND**

GENERAL LIGHT-DUTY & DIY PROFESSIONAL HEAVY-DUTY INDUSTRIAL EXTREME-DUTY

eco 1 Buy 2 Exchange 3 Save **tested**

B **EAB** EXCHANGE-A-BLADE **tested**

All EAB products are rigorously lab tested

eco 1 Buy 2 Exchange 3 Save **tested**

C **EAB** EXCHANGE-A-BLADE

1 Buy
2 Exchange
3 Save

eco **tested**

D **EAB** EXCHANGE-A-BLADE **Decking**

GEN

GREAT FOR DIY & PROFESSIONAL PROJECTS

- Engineered for ripping and crosscutting dimensional lumber
- Tough ATB carbide tooth configuration cuts wood fibers cleanly and quickly

eco 1 Buy 2 Exchange 3 Save **tested**

E **EAB** EXCHANGE-A-BLADE **Shelving**

GEN

GREAT FOR DIY & PROFESSIONALS

- Great for softwoods, hardwoods and composite materials
- Recommended for splinter-free cutting of moulding, panelling, veneers and hardwoods

eco 1 Buy 2 Exchange 3 Save **tested**

F **EAB** EXCHANGE-A-BLADE **GREEN BLADE**

ECO-FRIENDLY

- Manufactured without the use of Chromium
- Made with a portion of recycled carbide

GEN **FR**

Framing & Finishing
IDEAL FOR CONTRACTOR & DIY USE

eco 1 Buy 2 Exchange 3 Save **tested**

G **EAB** EXCHANGE-A-BLADE **Chop Saw Miter**

GEN

GREAT FOR DIY & PROFESSIONALS

- Ideal for quick miter work on the job site or for a DIY project
- Designed for miter and radial arm saws
- C2 carbide teeth with a -5° hook angle to avoid grabbing

eco 1 Buy 2 Exchange 3 Save **tested**

H **EAB** EXCHANGE-A-BLADE **Ultra Thin**

PRO

LOW WASTE / FAST CUTTING

- Thin kerf provides a faster, smoother cut
- Great for cordless or low-powered saws
- Ideal for cutting pressboard, veneers, panelling and fine hardwoods
- C3 grade carbide

eco 1 Buy 2 Exchange 3 Save **tested**

I **EAB** EXCHANGE-A-BLADE **All Purpose**

GEN

ALL PURPOSE STEEL BLADE

- Made from high quality steel
- Great multi-purpose blade
- Gives a good finish on wood products and may be used for ripping

eco 1 Buy 2 Exchange 3 Save **tested**

J **EAB** EXCHANGE-A-BLADE **Plywood**

GEN

PLYWOOD STEEL BLADE

- Made from high quality steel
- Designed for cutting cross-grain on wood
- Excellent for cutting 1/8" to 3/4" plywood and will also cut some soft plastics

eco 1 Buy 2 Exchange 3 Save **tested**

K **EAB** EXCHANGE-A-BLADE **Panelling**

GEN

PANELLING STEEL BLADE

- Made from high quality steel
- Small teeth designed to cut plywoods up to 1/2" and some thin plastics
- Chip free cutting

eco 1 Buy 2 Exchange 3 Save **tested**

L **EAB** EXCHANGE-A-BLADE **Steel Sheeting**

GEN

STEEL SHEETING STEEL BLADE

- Made from high quality steel
- Designed for smooth, fast cutting of sheet metal, corrugated steel roofing, siding and partition studding up to 1/8" inch

eco 1 Buy 2 Exchange 3 Save **tested**

A	3SGN801HE	EAB Blades Pegboard
B	3SGN802HE	EAB All EAB products are tested Pegboard
C	3SGN804HE	EAB All EAB Prorame Pegboard
D	3SGN810HE	EAB General Decking Pegboard
E	3SGN811HE	EAB General Shelving Pegboard
F	3SGN812HE	EAB General Green Blade Pegboard
G	3SGN814HE	EAB General Chop Saw Miter Pegboard
H	3SGN815HE	EAB General Chop Saw Miter Pegboard
I	3SGN816HE	EAB General All Purpose Pegboard
J	3SGN817HE	EAB General Plywood Pegboard
K	3SGN818HE	EAB General Panelling Pegboard
L	3SGN819HE	EAB General Steel Sheeting Pegboard

3SGN---HF for french cards

A **EAB** **Green Series Diamond Blades**

SEGMENTED **FAST & LONG-LASTING** **SMOOTH & FAST** **SMOOTHEST CUT**

Ideal for rough cuts of concrete or masonry products
Best for fine cuts of concrete or masonry products
Designed for tile, porcelain, slate and marble

Wet cutting is recommended to extend blade life

GEN

eco 1 Buy 2 Exchange 3 Save **fested**

B **EAB** **Framing**

HEAVY-DUTY BLADE

- Engineered for ripping and crosscutting dimensional lumber
- Tough ATB carbide tooth configuration cuts wood fibers cleanly and quickly

PRO

eco 1 Buy 2 Exchange 3 Save **fested**

C **EAB** **Cabinetry**

SMOOTH FINISH

- Great for softwoods, hardwoods and composite materials
- Recommended for splinter-free cutting of moulding, panelling, veneers and hardwoods

PRO

eco 1 Buy 2 Exchange 3 Save **fested**

D **EAB** **Ultra Thin**

LOW WASTE / FAST CUTTING

- Thin leaf provides a faster, smoother cut
- Great for cordless or low-powered saws
- Ideal for cutting pressboard, veneers, panelling and fine hardwoods
- C3 grade carbide

PRO

eco 1 Buy 2 Exchange 3 Save **fested**

E **EAB** **RAZOR BACK**

ONE OF THE TOUGHEST AND SAFEST

- High impact blade
- Sockettooth design reduces tooth loss
- Anti-kickback shoulder eliminates grabbing

Lasts **50% longer** Ultra Fast

PRO

eco 1 Buy 2 Exchange 3 Save **fested**

F **EAB** **Melamine & Laminates**

SPLINTER-FREE CUTS

- Extra fine finishing blade
- Triple chip grind (TCG) tooth configuration with C2 grade carbide
- For use on melamine, laminates & hard plastics

PRO

eco 1 Buy 2 Exchange 3 Save **fested**

G **EAB** **All Purpose**

A MUST HAVE HEAVY-DUTY BLADE

- Designed for both fast ripping and semi-smooth crosscutting
- The C2 grade carbide ATB tooth configuration makes this blade perfect for a wide variety of wood materials

PRO

eco 1 Buy 2 Exchange 3 Save **fested**

H **EAB** **Metal**

HEAVY-DUTY BLADE

- Safely cut mild steel roofing, metal siding and steel studs up to .062 gauge
- Hardened plate, thin leaf, strong chip limiting shoulders and low hook angles reduce jamming, overfeeding and overheating

PRO

eco 1 Buy 2 Exchange 3 Save **fested**

I **EAB** **Miter-Wood**

SMOOTH CUTS

- Fine finishing
- Designed for miter and radial arm saws
- High grade C3 carbide teeth with a -5° hook angle to avoid grabbing

PRO

eco 1 Buy 2 Exchange 3 Save **fested**

M **EAB** **Miter-Aluminum**

HEAVY-DUTY BLADE

- Triple chip grind (TCG) C6 grade carbide tooth configuration with a -5° hook angle
- Designed for smooth and safe cutting of non-ferrous metals such as aluminum, copper and brass

PRO

eco 1 Buy 2 Exchange 3 Save **fested**

K **EAB** **Fiber Cement**

LOW DUST HEAVY-DUTY BLADE

- Easily cuts through a single layer of fiber cement construction material
- Over 900 cuts on a single layer 8" x 3/8" HardiePlank®

ideal for **HardiePlank®** **CemPlank®**

PRO

eco 1 Buy 2 Exchange 3 Save **fested**

L **EAB** **RAZOR TOOTH PRO**

ULTIMATE FINISHING

- Heavy-duty
- Mirror finish C3 grade carbide teeth
- Ultra smooth cutting of hardwoods, panelling and laminates

C3 High ATB

PRO

eco 1 Buy 2 Exchange 3 Save **fested**

A	3SGN830HE	EAB General Green Series Diamond Blades Pegboard
B	3SGN850HE	EAB Professional Framing Pegboard
C	3SGN851HE	EAB Professional Cabinetry Pegboard
D	3SGN852HE	EAB Professional Ultra Thin Pegboard
E	3SGN853HE	EAB Professional Razor Back Pegboard
F	3SGN854HE	EAB Professional Melamine & Laminates Pegboard
G	3SGN855HE	EAB Professional All Purpose Pegboard
H	3SGN856HE	EAB Professional Metal Pegboard
I	3SGN857HE	EAB Professional Miter-Wood Pegboard
J	3SGN858HE	EAB Professional Miter-Aluminum Pegboard
K	3SGN859HE	EAB Professional Fiber Cement Pegboard
L	3SGN860HE	EAB Professional Razor Tooth Pro Pegboard

3SGN---HF for french cards

A **EAB** EXCHANGE-A-BLADE **Framing**

EXTREME-DUTY BLADE

- Engineered for ripping and crosscutting dimensional lumber
- Tough C4 grade ATB carbide tooth configuration cuts wood fibers cleanly and quickly

IND

eco 1 Buy 2 Exchange 3 Save **tested**

B **EAB** EXCHANGE-A-BLADE **Cabinetry**

EXTREME-DUTY / SMOOTH FINISH

- Great for softwoods, hardwoods and composite materials
- Recommended for splinter-free cutting of moulding, panelling, veneers and hardwoods

IND

eco 1 Buy 2 Exchange 3 Save **tested**

C **EAB** EXCHANGE-A-BLADE **Melamine & Laminates**

LONGEST LASTING SPLINTER-FREE CUTS

- Extra fine finishing blade
- Triple chip grind (TCG) tooth configuration with C4 grade carbide
- For use on melamine, laminates & hard plastics

IND

eco 1 Buy 2 Exchange 3 Save **tested**

D **EAB** EXCHANGE-A-BLADE **All Purpose**

A MUST HAVE EXTREME-DUTY BLADE

- Longest lasting, designed for both fast ripping and semi-smooth crosscutting
- The C4 grade carbide ATBR tooth configuration makes this blade perfect for a wide variety of wood materials

IND

eco 1 Buy 2 Exchange 3 Save **tested**

E **EAB** EXCHANGE-A-BLADE **Miter-Wood**

SMOOTH CUTS

- Fine finishing and longest lasting
- Designed for miter and radial arm saws
- High grade C4 carbide teeth with a -5° hook angle to avoid grabbing

IND

eco 1 Buy 2 Exchange 3 Save **tested**

F **EAB** EXCHANGE-A-BLADE **Miter - Aluminum**

LONG LIFE EXTREME-DUTY BLADE

- Triple chip grind (TCG) C4 grade carbide tooth configuration with a -5° hook angle
- Designed for smooth and safe cutting of non-ferrous metals such as aluminum, copper and brass

IND

eco 1 Buy 2 Exchange 3 Save **tested**

G **EAB** EXCHANGE-A-BLADE **Metal**

LONG LASTING EXTREME-DUTY BLADE

- Safely cut mild steel roofing, metal siding and steel studs up to .062 gauge
- Hardened plate, thin kerf, strong chip limiting shoulders and low hook angles reduce jamming, overheating and overheating

IND

eco 1 Buy 2 Exchange 3 Save **tested**

H **EAB** EXCHANGE-A-BLADE **Fiber Cement**

LOW DUST EXTREME-DUTY BLADE

- Cut through multiple layers of fiber cement construction material
- Feature poly-crystalline diamond (PCD) carbide teeth that can last for over 10,000 cuts on a single layer 8" x 3/8" HardiePlank®

IND

eco 1 Buy 2 Exchange 3 Save **tested**

ideal for HardiePlank® Complanck®

I **EAB** EXCHANGE-A-BLADE **RAZOR TOOTH**

ULTIMATE FINISHING

- Extreme-duty longest lasting
- Mirror finish C4 grade carbide
- Ultra smooth cutting of hardwoods, panelling and laminates

IND

eco 1 Buy 2 Exchange 3 Save **tested**

M **EAB** EXCHANGE-A-BLADE **Laser Line**

Specially designed with anti-vibration & noise reducing vents

LASER LINE

MITER WOOD
Fine splinter free cutting of wood products

MITER ALUMINUM
Safe smooth cutting of metals such as brass, copper and aluminum

ALL PURPOSE
For both fast ripping and semi-smooth crosscutting

BRICKMANN
Designed for melamine, laminates and hard plastics

IND

eco 1 Buy 2 Exchange 3 Save **tested**

K **EAB** EXCHANGE-A-BLADE **Contractor Series Diamond Blades**

FAST & LONG LASTING
Ideal for rough cuts of concrete or masonry products

SMOOTH & FAST
Best for finer cuts of concrete or masonry products

SMOOHEST CUT
Designed for tile, porcelain, slate, marble and granite

IND

eco 1 Buy 2 Exchange 3 Save **tested**

A	3SGN870HE	EAB Industrial Framing Pegboard
B	3SGN871 HE	EAB Industrial All Purpose Pegboard
C	3SGN872 HE	EAB Industrial Melamine & Laminates Pegboard
D	3SGN873HE	EAB Industrial All Purpose Pegboard
E	3SGN874HE	EAB Industrial Miter-Wood Pegboard
F	3SGN875HE	EAB Industrial Miter-Aluminum Pegboard
G	3SGN876HE	EAB Industrial Metal Pegboard
H	3SGN878HE	EAB Industrial Fiber Cement Pegboard
I	3SGN879HE	EAB Industrial Razor Tooth Ind Pegboard
J	3SGN880HE	EAB Industrial Laser Line Pegboard
K	3SGN890HE	EAB Industrial Contractor Series Diamond Blades Pegboard

3SGN---HF for french cards



WIRE BRUSHES

Long lasting brushes for cleaning, polishing and deburring
Carbon steel • For power drills, angle grinders and bench grinders



BROSSES MÉTALLIQUES

Brosses de longue durée pour le nettoyage, le polissage et l'ébarbage
Acier au carbone • Pour les perceuses, meuleuses d'angle et meuleuses d'établi

3SGN144E & 3SGN144F - SS GEN Wire Brushes, 12" x 4"



RECIPROCATING BLADES

For all tough construction and demolition work
High Speed Steel • Bimetal teeth • Fits all reciprocating saws



LAMES POUR SCIE ALTERNATIVE

Pour les travaux de construction et démolition intenses
Acier Rapide • Dents métalliques • S'adaptent à toutes scies alternatives



3SGN134E & 3SGN134F - SS IND Recips, 14" x 4"



DIAMOND BLADES

The right blade for every job: Segmented • Turbo • Continuous
Wet or dry cutting* • High diamond concentration • Long life



LAMES DIAMANTÉES

Une lame pour chaque tâche: Segmentée • Turbo • Continue
Coupe à sec ou à l'eau* • Haute concentration de diamants • Longue vie



3SGN369E & 3SGN369F - SS GEN/PRO/IND, Diamond Blades, 14" x 4"



ABRASIVES

The fastest, longest lasting wheels for cutting, grinding, sanding & polishing
Stainless Steel • Ferrous & Non-Ferrous Metals • Masonry



ABRASIFS

Les lames les plus rapides et de longues durées pour couper, meuler, poncer et polir
Acier Inoxydable • Métaux ferreux et non-ferreux • Maçonnerie



3SGN099E & 3SGN099F - SS PRO/IND Abrasives, 14" x 4"



OSCILLATING TOOL ACCESSORIES

Cut it. Scrape it. Sand it. Grind it. Remove it.
Fast, precision made tools designed to fit most major brands



ACCESSOIRES D'OUTIL OSCILLANTS

Coupez, meulez, raclez et sablez
Accessoires de précision pour outils oscillants



3SGN145E & 3SGN145F - EAB/SS Double-sided, PRO OTA, 14" x 4"



DIAMOND HOLE SAWS

Long lasting diamonds for fast, precise, chip-free cuts
For handheld or press drills • Must be used with water



SCIES EMPORTE-PIÈCES DIAMANTÉS

Diamants durables pour des coupes rapides et précises sans fragments
Pour perceuses à main ou à colonne • Doit être utilisé avec de l'eau



3SGN372E & 3SGN372F - SS GEN & PRO Diamond HS, 12" x 4"

With only a couple exceptions, all headers are now single-sided - either English or French.

STAY SHARP by EAB

testé

IND INDUSTRIAL QUALITY EXTREME-DUTY

JIG SAW BLADES

Swiss made with high grade steel for ultimate speed and durability
Bimetal - HSS High Speed Steel - HCS High Carbon Steel

STAY SHARP by EAB

testé

IND QUALITÉ INDUSTRIELLE TRAVAUX INTENSIFS

LAME DE SCIE SAUTEUSE

Fabrication Suisse pour durabilité et vitesse ultime
Bimétal - Acier Rapide - Acier Haut Carbone

3SGN333E & 3SGN333F - SS IND Jig Saw, 12" x 4"

STAY SHARP by EAB

testé

IND INDUSTRIAL QUALITY EXTREME-DUTY

IMPACT & SCREWDRIVER BITS

A full assortment of bits for every application
Impact - Decking - Drywall - Nutsetters - Bit holders

STAY SHARP by EAB

testé

IND QUALITÉ INDUSTRIELLE TRAVAUX INTENSIFS

**EMBOUS IMPACT
EMBOUS DE TOURNEVIS**

Un assortiment complet d'embouts pour chaque application
Impact - Vis à terrasse - Douille - Porte-embout

3SGN065E & 3SGN065F - SS IND Impact & SD Bits, 7 1/4" x 5 1/4"

STAY SHARP by EAB

testé

IND INDUSTRIAL QUALITY EXTREME-DUTY

IMPACT & SCREWDRIVER BITS

A full assortment of bits for every application
Impact - Decking - Drywall - Nutsetters - Bit holders

STAY SHARP by EAB

testé

IND INDUSTRIAL QUALITY EXTREME-DUTY

IMPACT & SCREWDRIVER BITS

A full assortment of bits for every application
Impact - Decking - Drywall - Nutsetters - Bit holders

3SGN067E & 3SGN067F - SS IND Impact & SD Bits, 10 3/4" x 5 1/4"

STAY SHARP by EAB

testé

IND INDUSTRIAL QUALITY EXTREME-DUTY

IMPACT & SCREWDRIVER BITS

A full assortment of bits for every application
Impact - Decking - Drywall - Nutsetters - Bit holders

STAY SHARP by EAB

testé

IND QUALITÉ INDUSTRIELLE TRAVAUX INTENSIFS

EMBOUS IMPACT - EMBOUS DE TOURNEVIS

Un assortiment complet d'embouts pour chaque application
Impact - Vis à terrasse - Douille - Porte-embout

3SGN068E & 3SGN068F - SS IND Impact & SD Bits, 14" x 4 1/2"

Section Headers (4 foot)

STAY SHARP by EAB

testé

GEN GENERAL QUALITY CONTRACTOR & DIY USE

PRO PROFESSIONAL QUALITY HEAVY-DUTY

IND INDUSTRIAL QUALITY EXTREME-DUTY

POWER TOOL ACCESSORIES

3SGN614E - 4' x 7" Section Header - SS OTA, styrene, En

STAY SHARP by EAB

testé

GEN QUALITÉ GÉNÉRALE CONTRACTEUR & BRICOLAGE

PRO QUALITÉ PROFESSIONNELLE TRAVAUX LOUDS

IND QUALITÉ INDUSTRIELLE TRAVAUX INTENSIFS

ACCESSOIRES D'OUTILS ÉLECTRIQUES

3SGN614F - 4' x 7" Section Header - SS OTA, styrene, Fr

These multi-purpose signs can be used on any flat surface and attached with double-sided foam tape.

A Eco-2-Go Headers

EAB
EXCHANGE-A-BLADE

1 Buy
Our complete line of power tool accessories is made to exacting specifications. Rigorous testing guarantees the highest quality and performance.

Don't see what you need — ask your dealer or visit EABTool.com.

2 Exchange
When your EAB tool is worn or dull, simply return it to your dealer. Apply the **Exchange Credit** towards your next EAB purchase.

3 Save
With the **Exchange System**, you'll see significant savings over buying comparable competitors' products.

Compare for yourself and discover all the benefits of EAB.

eco
Build better. *Économisez mieux.*

EAB
EXCHANGE-A-BLADE

1 Achetez
Tous nos accessoires d'outils électriques sont fabriqués selon les normes les plus strictes et sont soumis à des tests rigoureux. Cela vous garantit la plus haute qualité et performance.

Vous ne trouvez pas ce que vous avez besoin — demandez à votre marchand ou visitez EABTool.com.

2 Échangez
Lorsque votre accessoire d'outil EAB est émoussé, retournez-le chez votre marchand. Appliquez le **Crédit d'Échange** vers votre prochain achat EAB.

3 Économisez
Une fois dans le **Système d'Échange**, vous économiserez un montant considérable à comparer aux produits de nos concurrents.

Comparez pour vous-même et découvrez les avantages EAB.

eco
Build better. *Économisez mieux.*

EAB
EXCHANGE-A-BLADE

1 Buy
Select the perfect power tool accessory from over 500 exchangeable high-performance power tool accessories.

Don't see what you need — ask your dealer or visit EABTool.com.

2 Exchange
When it's dull and ready to be replaced, simply return it to your retail store, and apply the credit towards a new one.

3 Save
With the green exchange system, you'll get significant savings over buying comparable competitors' products.

eco
Build better. *Économisez mieux.*

	3SGN616E	22" x 6" Eco2-Go Header, double-sided En/En
A	3SGN616F	22" x 6" Eco2-Go Header, double-sided Fr/Fr
	3SGN618E	22" x 6" Eco2-Go Header, double-sided En/En

B Wall Mounted Blade Guide

EAB
EXCHANGE-A-BLADE

1 Buy
Our complete line of more than 125 blades is made to exacting specifications. Rigorous testing guarantees the highest quality and performance.

Don't see what you need — ask your dealer or visit EABTool.com.

2 Exchange
When your blade is dull, simply return it to your dealer. Apply the **Exchange Credit** towards your next EAB purchase.

3 Save
With the **Exchange System**, you'll see significant savings over buying comparable competitors' products.

Compare for yourself and discover all the benefits of EAB.

eco
Build better. *Économisez mieux.*

EAB
EXCHANGE-A-BLADE

Right Quality
GEN GENERAL QUALITY Light Contractor & DIY Use
PRO PROFESSIONAL QUALITY Heavy-Duty Use
IND INDUSTRIAL QUALITY Extreme-Duty Use

Right Blade
Construction Lumber & Composites Plywood
Cabinetry Shelving Moulding
Laminates Melamine Plastics
Hardwoods Paneling Trim
Framing
RazorBack Ultra Fast High Impact
All Purpose
Miter - Wood
Finishing
Ultra Thin
Laminates
Metal
Fiber
Fiber Composites
Non-Ferrous Metals Plastics
Ferrous Metals
Miter
Metal
Ultimate Flashing **RAZOR TOOTH**
Ultimate Industrial **LASER**

eco
Build better. *Économisez mieux.*

EAB
EXCHANGE-A-BLADE

1 Achetez
Notre gamme complète comprend plus de 125 lames fabriquées selon les normes les plus strictes et soumises à des tests rigoureux. Cela vous garantit la plus haute qualité et performance.

Vous ne trouvez pas ce que vous avez besoin — demandez à votre marchand ou visitez EABTool.com.

2 Échangez
Lorsque votre lame EAB est émoussée, retournez-la chez votre marchand. Appliquez le **Crédit d'Échange** vers votre prochain achat EAB.

3 Économisez
Une fois dans le **Système d'Échange**, vous économiserez un montant considérable à comparer aux produits de nos concurrents.

Comparez pour vous-même et découvrez les avantages EAB.

eco
Build better. *Économisez mieux.*

EAB
EXCHANGE-A-BLADE

Qualité
GEN QUALITÉ GÉNÉRALE Travaux Légers et bricolage
PRO QUALITÉ PROFESSIONNELLE Travaux Lourds
IND QUALITÉ INDUSTRIELLE Travaux Intenses

Lame
Bois de Construction Contreplaqué
Ébénisterie Étagères Moulures
Laminés Melamines Plastics
Bois Dur Lamebris Plaquage
Charpente
RazorBack Ultra-Rapide Impact Élevé
Tout Usage
Onglet - Bois
Finition
Ultra Mince
Laminates
Métal
Fibrociment
Métaux Non-Ferreux Plastics
Métaux Ferreux
Onglet
Métal
Finition Ultra Fine
Industrielle Ultra Fine **RAZOR TOOTH**
Industrielle Ultra Fine **LASER**

eco
Build better. *Économisez mieux.*

B	3SGN008E	7" x 21" Blade Guide btwn Wings (2 pcs) , En
	3SGN008F	7" x 21" Blade Guide btwn Wings (2 pcs) , Fr

Pro & Ind Hole Saws <

8-Shelf Rack Comprising:



- Shelf 1-2: 4 rows, 3/4" deep, 10"W, 7"L
Shelf 1 holds: 3/4", 7/8", 1", 1 1/8"
Shelf 2 holds: 1 1/4", 1 3/8", 1 1/2", 1 5/8"
- Shelf 3: 5 rows, 1 1/4" deep, 11"W, 10"L
Shelf 3 holds: 1 3/4", 1 7/8", 2", 2 1/8", 2 1/4"
- Shelf 4-6: 5 rows, 1 3/4" deep, 11"W, 10"L
Shelf 4 holds: 2 3/8", 2 1/2", 2 5/8", 2 3/4", 3"
Shelf 5 holds: 3 1/8", 3 1/4", 3 3/8", 3 1/2", 3 5/8"
Shelf 6 holds: 3 3/4", 3 7/8", 4", 4 1/8", 4 1/4"
- Shelf 7: 5 rows, 1 3/4" deep, 11"W, 11.5"L
Shelf 7 holds: 4 1/2", 4 3/4", 5", 5 1/4", 5 1/2"
- Shelf 8: 4 rows 3 1/2" deep, 10.5W, 14"L
Shelf 8 holds: 6", 6 1/4", 6 5/8", 7 7/8"

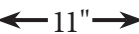

3RCK080	Wire Racking - includes 8 shelves
3RCK079	U Mount Wall Bracket for mounting to plywood or slatwall (1" x 1" x 48") Requires 2
3RCK119	4" Safety Loop Hook
3POPO84	Price Channel Insert Strips, complete set for 1 rack, white, cut to length. Includes 2 strips for shelves 1&2, to be pinned to the back of the shelves. *N.B. These are only required for existing shelving. New racks (Aug 2014 onwards) have a flat plate to receive stickers.

New Rack Same Item #3RCK080.

Flat pricing plate replaces old price channel design. Shelf 1 has pricing plate at the back, all others at the front.

Dimensions remain the same.



POP Required

EAB EXCHANGE-A-BLADE **Pro** **Tested**

Bimetal Hole Saws

50 cuts in 1/4" steel tubing vs. competitors' 20-40
M2 High Speed Steel - 4/6 tooth configuration - 1 1/4" depth

1 Buy
2 Exchange
3 Save **ecp**

INDUSTRIAL QUALITY
EXTREME DUTY

EAB EXCHANGE-A-BLADE **Pro** **Testé**

Scies Emporte-Pièces Bimétal

50 coupes dans les tubes en acier 1/4" vs 20 à 40 pour les concurrents
Acier rapide M2 - Configuration 4/6 variable des dents - Profondeur de 1 1/4"

1 Achetez
2 Échangez
3 Économisez **ecp**

QUALITÉ INDUSTRIELLE
RÉSISTANCE EXTRAORDINAIRE

3SGN081E & 3SGN081F - EAB PRO Bimetal HS, 12" x 4"

EAB EXCHANGE-A-BLADE **Ind** **Tested**

Bimetal Hole Saws

80 cuts in 1/4" steel tubing vs. competitors' 20-50
M3 High Speed Steel - 4/6 tooth configuration - 1 1/4" depth

1 Buy
2 Exchange
3 Save **ecp**

INDUSTRIAL QUALITY
EXTREME DUTY

EAB EXCHANGE-A-BLADE **Ind** **Testé**

Scies Emporte-Pièces Bimétal

80 coupes dans les tubes en acier 1/4" vs 20 à 50 pour les concurrents
Acier rapide M3 - Configuration 4/6 variable des dents - Profondeur de 1 1/4"

1 Achetez
2 Échangez
3 Économisez **ecp**

QUALITÉ INDUSTRIELLE
RÉSISTANCE EXTRAORDINAIRE

3POPO45E & 3POPO45F - EAB IND Bimetal HS, 12" x 4"



Ind M42 Cobalt Hole Saws <

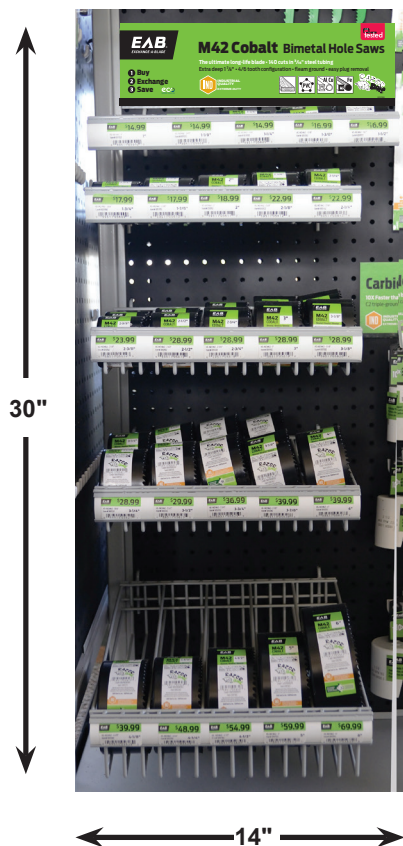

5-Shelf Rack Comprising:

- Shelf 1: 5 rows, 1" deep, 14"W, 7 1/4"L
shelf 1 holds: 1", 1 1/8", 1 1/4", 1 3/8", 1 1/2"
- Shelf 2: 5 rows, 1 3/8" deep, 1 7/8"W, 9 3/4"L
shelf 2 holds: 1 3/4", 1 7/8", 2", 2 1/8", 2 1/4"
- Shelf 3-4: 5 rows, 2" deep, 11 7/8"W, 9 3/4"L
shelf 3 holds: 2 3/8", 2 1/2", 2 3/4", 3", 3 1/8"
shelf 4 holds: 3 1/4", 3 1/2", 3 3/4", 3 7/8", 4"
- Shelf 5: 5 rows, 2 3/4" deep, 11 7/8"W, 13 1/2"L
shelf 5 holds: 4 1/8", 4 1/4", 4 1/2", 5", 6"

3POP046 Price Channel Insert Strips, complete set of 5 strips for 1 rack, white, cut to length.

POP Required

3RCK083 Wire Racking - includes 5 shelves

EAB
EXCHANGE-A-BLADE

M42 Cobalt Bimetal Hole Saws

The ultimate long-life blade • 140 cuts in 3/16" steel tubing
Extra deep 1 7/8" • 4/6 tooth configuration • flean ground • easy plug removal

1 Buy
2 Exchange
3 Save

IND INDUSTRIAL QUALITY EXTREME-DUTY

EAB
EXCHANGE-A-BLADE

Cobalt M42 Scies Emporte-Pièces Bimétal

La lame longue vie ultime • 140 coupes dans les tubes en acier 3/16"
Corps extra long 1 7/8" • Configuration 4/6 variable des dents • Retire facilement les copeaux

1 Achetez
2 Échangez
3 Économisez

IND QUALITÉ INDUSTRIELLE TRAVAUX INTENSIFS

3POP083E & 3POP083F - EAB IND M42 HS, 14" x 4"

Flute Wood Augers

EAB
EXCHANGE-A-BLADE

4 Flute Wood Augers

Four cutting spurs for faster cleaner bores in all types of wood
1/4" quick-change shank • Self-feeding screw point • 4" depth

1 Buy
2 Exchange
3 Save

GEN GENERAL QUALITY CONTRACTOR & DIY USE

X4+ ULTRAFAST

EAB
EXCHANGE-A-BLADE

Mèches Tarière à Bois

4 tranchants pour percer plus nettement et rapidement à travers le bois
Tige 1/4" à changement rapide • Compatible avec les outils à percussion
Pointe à filets • Profondeur de 4"

1 Achetez
2 Échangez
3 Économisez

GEN QUALITÉ GÉNÉRALE CONTRACTOR & BRICOLAGE

X4+ ULTRA RAPIDE

3SGN073E & 3SGN073F - 4 Flute Wood Augers, 12" x 4"



3RCK117	Router Bit Case with lock
3RCK117Door	Replacement Door
3SGN118E	14" x 4" Header - PRO Router Bits - English
3SGN118F	14" x 4" Header - PRO Router Bits - French
3SGN119E	14" x 4" Header - IND Router Bits - English
3SGN119F	14" x 4" Header - IND Router Bits - French

EAB
EXCHANGE-A-BLADE

Router Bits

Ultra fine results in wood, laminates and composites
Tungsten carbide cutters • 50+ profiles • ¼" & ½" shanks • Enclosed bearings

1 Buy
2 Exchange
3 Save *eco*

PRO PROFESSIONAL QUALITY HEAVY-DUTY

tested

3SGN118E & 3SGN118F - EAB PRO Router Bits, 14" x 4"

EAB
EXCHANGE-A-BLADE

Mèches de Toupie

Finition ultra fine du bois, stratifié et composite
Tranchants en carbure de tungstène • 50+ profils • Tiges ¼" & ½" • Roulements étanches

1 Achetez
2 Échangez
3 Économisez *eco*

PRO QUALITÉ PROFESSIONNELLE TRAVAUX LOURDS

testé

EAB
EXCHANGE-A-BLADE

Router Bits

Ultra fine results in wood, laminates and composites
Tungsten carbide cutters • 50+ profiles • ¼" & ½" shanks • Enclosed bearings

1 Buy
2 Exchange
3 Save *eco*

IND INDUSTRIAL QUALITY EXTREME-DUTY

tested

3SGN119E & 3SGN119F - EAB IND Router Bits, 14" x 4"

EAB
EXCHANGE-A-BLADE

Mèches de Toupie

Finition ultra fine du bois, stratifié et composite
Tranchants en carbure de tungstène • 50+ profils • Tiges ¼" & ½" • Roulements étanches

1 Achetez
2 Échangez
3 Économisez *eco*

IND QUALITÉ INDUSTRIELLE TRAVAUX LÉGERS

testé

Reciprocating Blades <

Our intention is to redesign our recip racks with integrated pricing and POP, but until then, we have a low-cost retrofitted solution to accept the new price stickers. This consists of a backboard and clips for a snap-together assembly.



A	3RCK133	6 Prong Gang Hook Mounts directly to peg/slat board or waterfall racks (2 required per waterfall rack)
B	3RCK132	Price Sticker Backboard, White Styrene, 7" wide, 1 required for ea. 3RCK133
C	3RCK253	Plastic Clips, 2 required for ea. 3RCK133 (pkg of 100)
D	3RCK250	Waterfall Rack - Top (1" from wall)
E	3RCK252	Waterfall Rack - Bottom (6" from wall)

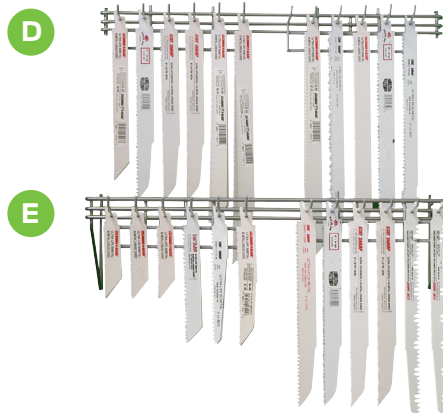

EAB EXCHANGE-A-BLADE EAB tested

Reciprocating Blades

For all tough construction and demolition work
High Speed Steel • Bimetal teeth • Fits all reciprocating saws

1 Buy
2 Exchange
3 Save

IND INDUSTRIAL QUALITY
EXTREME-DUTY

EAB EXCHANGE-A-BLADE EAB testé

Lames pour Scie Alternative

Pour les travaux de construction et démolition intenses
Acier Rapide • Dents bimétalliques • S'adaptent à toutes scies alternatives

1 Achetez
2 Échangez
3 Économisez

IND QUALITÉ INDUSTRIELLE
TRAVAUX INTENSIFS

3SGN133E & 3SGN133F - EAB IND Recips, 14" x 4"

STAY SHARP by EAB EAB tested

RECIPROCATING BLADES

For all tough construction and demolition work
High Speed Steel • Bimetal teeth • Fits all reciprocating saws

1 Buy
2 Exchange
3 Save

IND INDUSTRIAL QUALITY
EXTREME-DUTY

STAY SHARP by EAB EAB testé

LAMES POUR SCIE ALTERNATIVE

Pour les travaux de construction et démolition intenses
Acier Rapide • Dents métalliques • S'adaptent à toutes scies alternatives

1 Achetez
2 Échangez
3 Économisez

IND QUALITÉ INDUSTRIELLE
TRAVAUX INTENSIFS

3SGN134E & 3SGN134F - SS IND Recips, 14" x 4"

Reciprocating Blades <



A	3RCK202	Base for Recip Display
B	3RCK207	Large Plastic Holder (Holds 9" - 12" Recips)
C	3RCK208	Small Plastic Holder (Holds 6" - 9" Recips)
D	3POP202ECO	Stickers - Reciprocating Saw Blades Display - English
	3POP202ECOF	Stickers - Reciprocating Saw Blades Display - French



3RCK300E/F

comes with:

- 1 x EAB Clear Display #3RCK270 (Can hold 19 pieces)
- 5 x stickers (#3SGN300E/F)
- 1 x Bit holder for top panel (#93711)

Note:

18 bit holders #93711 not included

NEW



A



You will require 1 set for each spinner

3SGN280E & 3SGN280F - SS PRO IMPACT TORSION

B



3SGN290E & 3SGN290F - SS PRO IMPACT TORSION, 14" x 4"

NEW

Torsion Bit Display <

Made from durable ABS plastic with clear, plastic pockets. Pockets are angled for easy access. Moulded top houses an ABS molded removeable container which is perfect for larger bits.

A 40 Compartments

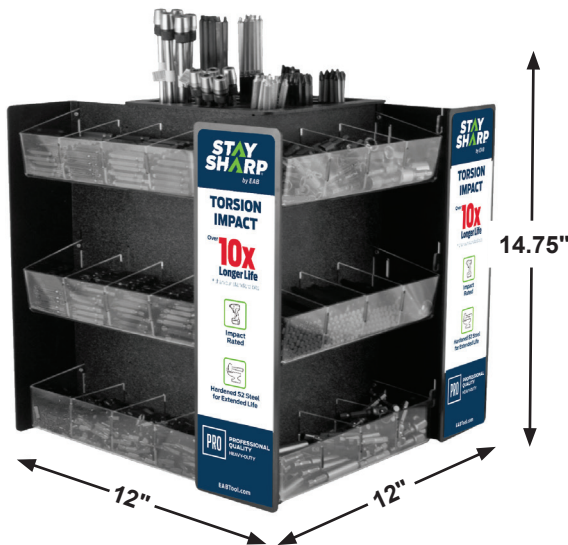

B 57 Compartments



A	3RCK246	40 Pocket Screwdriver Bit Spinner
	3RCK247	Lids for 40 Pocket Spinner (requires 12/display)
B	3RCK241	57 Pocket Screwdriver Bit Spinner
	3RCK248	Lids for 57 Pocket Spinner (requires 12/display) Replacement for broken/missing lids only. Display comes with lids.



POP and Bin Stickers for these merchandisers are on the following pages and must be ordered separately.

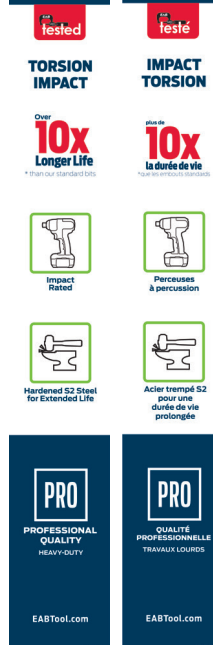

C	3SGN310E	Torsion Bits Center POP(57 Pocket), 1 set - English
D	3SGN310F	Torsion Bits Center POP(57 Pocket), 1 set - French

E	3SGN350E	Torsion Bits - English
F	3SGN350F	Torsion Bits - French

Short (2 pages)

Long (2 pages)



Stickers are available in both English and French

Stickers are available in both English and French

3SGN096E/F



3SGN096EL/FL

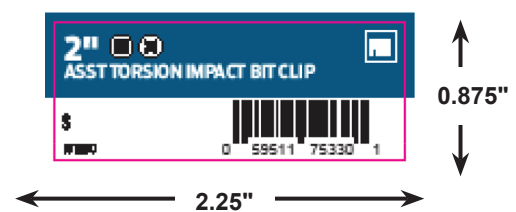

NEW

Item numbers and sizes are listed on the next page
See page 39 for complete list

76001	#2 x 1"	Torsion Impact Screwdriver Bit
76235	#2 x 1"	Torsion Impact Screwdriver Bit
75327	T25 x 1"	Torsion Impact Screwdriver Bit
76003	#1 x 2"	Torsion Impact Screwdriver Bit
76007	#2 x 2"	Torsion Impact Screwdriver Bit
76011	#3 x 2"	Torsion Impact Screwdriver Bit
76017	#1 x 3"	Torsion Impact Screwdriver Bit
76019	#2 x 3"	Torsion Impact Screwdriver Bit
76021	#3 x 3"	Torsion Impact Screwdriver Bit
76063	#1 x 6"	Torsion Impact Screwdriver Bit
76067	#2 x 6"	Torsion Impact Screwdriver Bit
76069	#3 x 6"	Torsion Impact Screwdriver Bit
76237	#1 x 2"	Torsion Impact Screwdriver Bit
76239	#2 x 2"	Torsion Impact Screwdriver Bit
76241	#3 x 2"	Torsion Impact Screwdriver Bit
76245	#1 x 3"	Torsion Impact Screwdriver Bit
76247	#2 x 3"	Torsion Impact Screwdriver Bit
76249	#3 x 3"	Torsion Impact Screwdriver Bit
76263	#1 x 6"	Torsion Impact Screwdriver Bit
76265	#2 x 6"	Torsion Impact Screwdriver Bit
76267	#3 x 6"	Torsion Impact Screwdriver Bit
76318	T10 x 2"	Torsion Impact Screwdriver Bit
76321	T15 x 2"	Torsion Impact Screwdriver Bit
76324	T20 x 2"	Torsion Impact Screwdriver Bit
76327	T25 x 2"	Torsion Impact Screwdriver Bit
76333	T30 x 2"	Torsion Impact Screwdriver Bit
76336	T40 x 2"	Torsion Impact Screwdriver Bit
75300	#2 x 2"	Torsion Impact Bit Clip
75310	#2 x 2"	Torsion Impact Bit Clip
75320	T20/T25 x 2"	Torsion Impact Bit Clip
75330	2"	Asst Torsion Impact Bit Clip
75340	2"	Asst Torsion Impact Bit Clip
76418	T10 x 3"	Torsion Impact Screwdriver Bit

76421	T15 x 3"	Torsion Impact Screwdriver Bit
76424	T20 x 3"	Torsion Impact Screwdriver Bit
76427	T25 x 3"	Torsion Impact Screwdriver Bit
76433	T30 x 3"	Torsion Impact Screwdriver Bit
76436	T40 x 3"	Torsion Impact Screwdriver Bit
76518	T10 x 6"	Torsion Impact Screwdriver Bit
76521	T15 x 6"	Torsion Impact Screwdriver Bit
76524	T20 x 6"	Torsion Impact Screwdriver Bit
76527	T25 x 6"	Torsion Impact Screwdriver Bit
76533	T30 x 6"	Torsion Impact Screwdriver Bit
76536	T40 x 6"	Torsion Impact Screwdriver Bit
76269	#2 x 12"	Torsion Impact Screwdriver Bit
76071	#2 x 12"	Torsion Impact Screwdriver Bit
76232	T20 x 12"	Torsion Impact Screwdriver Bit
76233	T25 x 12"	Torsion Impact Screwdriver Bit
76075	1/4" x 2-9/16"	Torsion Impact Nutsetter
76077	5/16" x 2-9/16"	Torsion Impact Nutsetter
76079	3/8" x 2-9/16"	Torsion Impact Nutsetter
76081	7/16" x 2-9/16"	Torsion Impact Nutsetter
76083	1/2" x 2-9/16"	Torsion Impact Nutsetter
76005	2"	Torsion Torx Asst
76105	2"	Torsion Torx Asst
76052	2-9/16"	Torsion Nutsetter
76152	2-9/16"	Torsion Nutsetter

Some items will be arriving at a later date, please check before placing your order.

Screwdriver & Impact Bit Spinners <

40 Compartments

Made from durable ABS plastic with clear, plastic pockets. Pockets are angled for easy access. Moulded top houses an ABS molded removeable container which is perfect for larger bits.

57 Compartments



SD & Impact Bit Centre

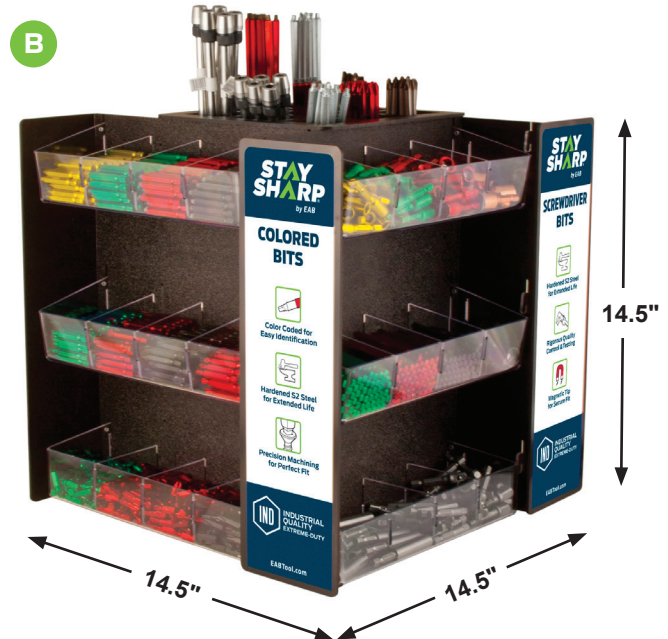

Versatile display has 22 pockets, 6 built in tower pockets and room for 10 bit clips (28 Bulk SKUs and 2 Bit Clips).

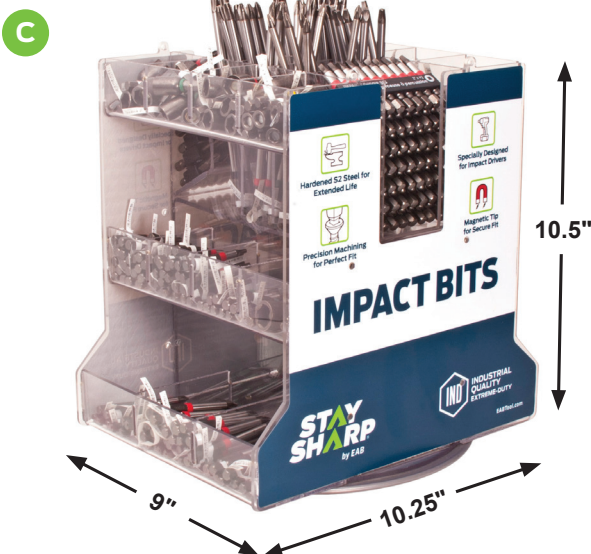

A	3RCK246	40 Pocket Screwdriver Bit Spinner
	3RCK247	Lids for 40 Pocket Spinner (requires 12/display)
B	3RCK241	57 Pocket Screwdriver Bit Spinner
	3RCK248	Lids for 57 Pocket Spinner (requires 12/display)
C	3RCK249	Clear Acrylic SB Display Rack

POP and Bin Stickers for these merchandisers are on the following pages and must be ordered separately.

Screwdriver & Impact Bit Spinners



for 40 & 57 Compartment Spinners 3RCK241 & 3RCK246

A

STAY SHARP
by EAB

COLORED BITS

Color Coded for Easy Identification

Hardened S2 Steel for Extended Life

Precision Machining for Perfect Fit

IND INDUSTRIAL QUALITY EXTREME-DUTY

EABTool.com

STAY SHARP
by EAB

EMBOUS COULEUR

Codes de couleur pour une identification facile

Acier S2 traité à la chaleur pour une durée prolongée

Usinage de précision pour une prise optimale

IND QUALITÉ INDUSTRIELLE TRAVAUX INTENSIFS

EABTool.com

B

STAY SHARP
by EAB

DECKING BITS

3" Tapered Tip fits Coated Decking Screws
*Not for Standard Potted Screws

Hardened S2 Steel for Extended Life

Rigorous Quality Control & Testing

IND INDUSTRIAL QUALITY EXTREME-DUTY

EABTool.com

STAY SHARP
by EAB

EMBOUS POUR VIS À TERRASSE

Pointe de 3" s'adapte mieux aux vis à terrasse traitées
*Non recommandé pour les vis standards

Acier S2 traité à la chaleur pour une durée prolongée

Contrôle de qualité rigoureux

IND QUALITÉ INDUSTRIELLE TRAVAUX INTENSIFS

EABTool.com

C

STAY SHARP
by EAB

IMPACT BITS

Specialty Designed for Impact Drivers

Hardened S2 Steel for Extended Life

Magnetic Tip for Secure Fit

IND INDUSTRIAL QUALITY EXTREME-DUTY

EABTool.com

STAY SHARP
by EAB

EMBOUS IMPACT

Conçue spécialement pour les perceuses à percussion

Acier S2 traité à la chaleur pour une durée prolongée

Pointe magnétique pour une meilleure prise

IND QUALITÉ INDUSTRIELLE TRAVAUX INTENSIFS

EABTool.com

D

STAY SHARP
by EAB

SCREWDRIVER BITS

Hardened S2 Steel for Extended Life

Rigorous Quality Control & Testing

Magnetic Tip for Secure Fit

IND INDUSTRIAL QUALITY EXTREME-DUTY

EABTool.com

STAY SHARP
by EAB

EMBOUS DE TOURNEVIS

Acier S2 traité à la chaleur pour une durée prolongée

Contrôle de qualité rigoureux

Pointe magnétique pour une meilleure prise

IND QUALITÉ INDUSTRIELLE TRAVAUX INTENSIFS

EABTool.com

E

STAY SHARP
by EAB

TORSION IMPACT

Over **10x** Longer Life
* than our standard bits

Impact Rated

Hardened S2 Steel for Extended Life

PRO PROFESSIONAL QUALITY HEAVY-DUTY

EABTool.com

STAY SHARP
by EAB

IMPACT TORSION

plus de **10x** la durée de vie
* plus que nos bits standards

Perceuses à percussion

Acier trempé S2

PRO QUALITÉ PROFESSIONNELLE TRAVAUX LOURDS

EABTool.com

You will require 2 sets for each spinner
These replace 3SGN242E1 POP LABEL KIT

A	3SGN240E	POP Labels (2), Colored Bits - English
	3SGN240F	POP Labels (2), Colored Bits - French
B	3SGN241E	POP Labels (2), Decking Bits - English
	3SGN241F	POP Labels (2), Decking Bits - French
C	3SGN239E	POP Labels (2), Impact Bits - English
	3SGN239F	POP Labels (2), Impact Bits - French
D	3SGN238E	POP Labels (2), Screwdriver Bits - English
	3SGN238F	POP Labels (2), Screwdriver Bits - French

E 3SGN310E Torsion Bits Center POP(57 Pocket), 1 set - English

F 3SGN310F Torsion Bits Center POP(57 Pocket), 1 set - French

Screwdriver & Impact Bit Spinners

Bit Spinner



for SD & Impact Bin Centre **3RCK249**

A



C

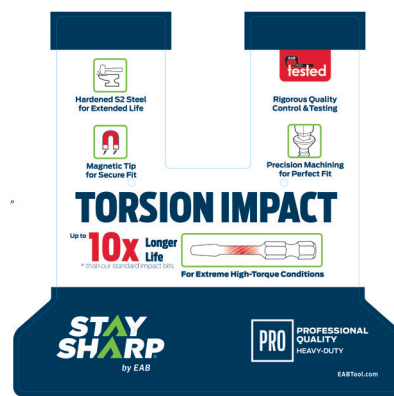

B

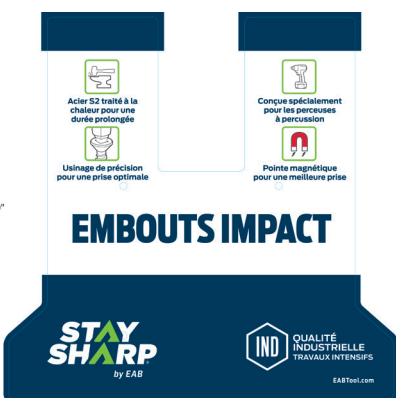

You will require 1 set for each spinner

A	3SGN250E	Screwdriver Bit Center POP, 1 set - English
	3SGN250F	Screwdriver Bit Center POP, 1 set - French
B	3SGN249E	Impact Center POP, 1 set - English
	3SGN249F	Impact Center POP, 1 set - French

You will require 1 set for each spinner

C	3SGN280E	Torsion Bit Center POP, 1 set - English
	3SGN280F	Torsion Bit Center POP, 1 set - French

Screwdriver & Impact Bit Spinners

Bit Spinner 3RCK268

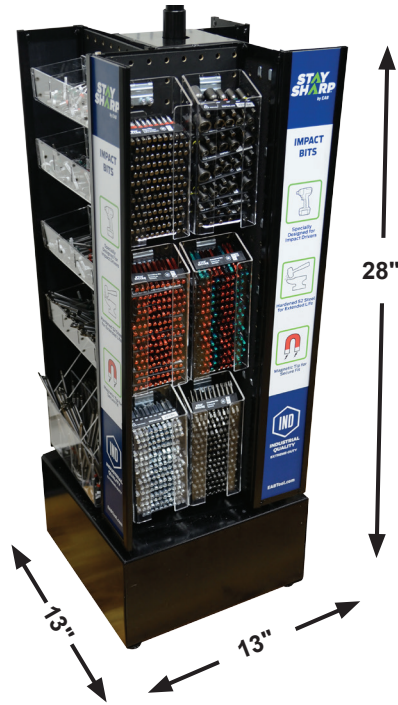

Bit Spinner

A	3SGN340E	Impact Bits - English
	3SGN340F	Impact Bits - French
B	3SGN341E	Screwdriver Bits - English
	3SGN341F	Screwdriver Bits - French
C	3SGN342E	Decking Bits - English
	3SGN342F	Decking Bits - French
D	3SGN343E	Colored Bits - English
	3SGN343F	Colored Bits - French
E	3SGN350E	Torsion Bits - English
	3SGN350F	Torsion Bits - French

A	B	C	D	A	B	C	D	E	F
STAY SHARP by EAB	STAY SHARP by EAB	STAY SHARP by EAB	STAY SHARP by EAB	STAY SHARP by EAB	STAY SHARP by EAB	STAY SHARP by EAB	STAY SHARP by EAB	STAY SHARP by EAB	STAY SHARP by EAB
IMPACT BITS	SCREWDRIVER BITS	DECKING BITS	COLORS BITS	EMBOUTS IMPACT	EMBOUTS DE TOURNEVIS	EMBOUTS POUR VIS À TERRASSE	EMBOUTS COULEUR	TORSION IMPACT	IMPACT TORSION
Specially Designed for Impact Drivers	Hardened S2 Steel for Extended Life	3" Tapered Tip Bits Coated Decking Screws <small>Meets the International Decking Standard</small>	Color Coded for Easy Identification	Conçue spécialement pour les perceuses à percussion	Acier S2 trempé pour une durée prolongée	Pointe de 3" s'adapte mieux aux vis à terrasse	Codes couleurs pour une identification facile	Over 10x Longer Life <small>* than our standard bits</small>	plus de 10x La durée de vie <small>* sur les embouts standards</small>
Hardened S2 Steel for Extended Life	Magnetic Tip for Secure Fit	Hardened S2 Steel for Extended Life	Hardened S2 Steel for Extended Life	Acier S2 trempé pour une durée prolongée	Pointe magnétique pour une meilleure prise	Acier S2 trempé pour une durée prolongée	Acier S2 trempé pour une durée prolongée	Impact Rated	Perçues à percussion
Magnetic Tip for Secure Fit	Rigorous Quality Control & Testing	Rigorous Quality Control & Testing	Precision Machining for Perfect Fit	Pointe magnétique pour une meilleure prise	Contrôle de qualité rigoureux	Contrôle de qualité rigoureux	Usage de précision pour une prise optimale	Hardened S2 Steel for Extended Life	Acier trempé S2 pour une durée de vie prolongée
IND	IND	IND	IND	IND	IND	IND	IND	PRO	PRO
INDUSTRIAL QUALITY EXTREME-DUTY	INDUSTRIAL QUALITY EXTREME-DUTY	INDUSTRIAL QUALITY EXTREME-DUTY	INDUSTRIAL QUALITY EXTREME-DUTY	QUALITÉ INDUSTRIELLE TRAVAUX EXTENSIFS	QUALITÉ INDUSTRIELLE TRAVAUX EXTENSIFS	QUALITÉ INDUSTRIELLE TRAVAUX EXTENSIFS	QUALITÉ INDUSTRIELLE TRAVAUX EXTENSIFS	PROFESSIONAL QUALITY HEAVY-DUTY	QUALITÉ PROFESSIONNELLE TRAVAUX LOUDS
EABTool.com	EABTool.com	EABTool.com	EABTool.com	EABTool.com	EABTool.com	EABTool.com	EABTool.com	EABTool.com	EABTool.com

Impact Bit Clips & Torsion Bit

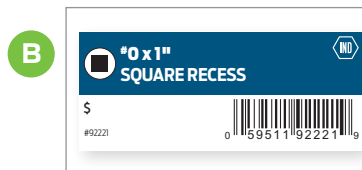

A	3RCK242	Rack for Bits
B	3RCK329	Label Holder, 2" x 1.25", pkg 100. Attaches to 3RCK328 (B), 3RCK333 (D) and 3RCK332 (F).
C	3SGN260E	PRO Impact Bits Clips Header - English
D	3SGN260F	PRO Impact Bits Clips Header - French
E	3SGN290E	Torsion Bit Pegboard, 1 set - English
F	3SGN290F	Torsion Bit Pegboard, 1 set - French



3SGN260E & 3SGN260F - PRO Impact Bits Clips

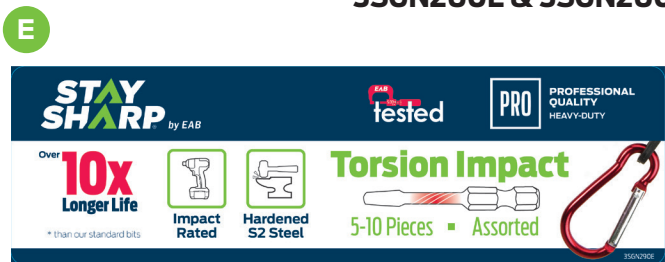

3SGN290E & 3SGN290F - PRO Torsion Impact Bits Clips



3SGN261E & 3SGN261F - PRO Impact Bits Clips

Paper Labels

For use on spinners/racks that have old permanent paper stickers. These cover over the old stickers ("L" for large) and are not removable.

3SGN087E	Industrial Standard - English (3 pg), paper
3SGN087F	Industrial Standard - French (3 pg), paper
3SGN088E	Industrial Coloured - English (2 pg), paper
3SGN088F	Industrial Coloured - French (2 pg), paper
3SGN089E	Industrial Banded - English (2 pg), paper
3SGN089F	Industrial Banded - French (2 pg), paper
3SGN090E	Impact - English (2 pg), paper
3SGN090F	Impact - French (2 pg), paper
3SGN254E	PRO - 7 Series Coloured, 1 pc - English (1 pg), paper
3SGN254F	PRO - 7 Series Coloured, 1 pc - French (1 pg), paper
3SGN093E	Impact - English (2), paper (Fits clear spinner 3RCK249)
3SGN093F	Impact - French (2), paper (Fits clear spinner 3RCK249)

Vinyl Labels

For use on all new setups and clean, smooth surfaces. These stickers are smaller than the old versions, and are the new standard, as the single size fits all bit spinners and are removable.

3SGN087E	Industrial Standard - English (3 pg), vinyl
3SGN087F	Industrial Standard - French (3 pg), vinyl
3SGN088E	Industrial Coloured - English (2 pg), vinyl
3SGN088F	Industrial Coloured - French (2 pg), vinyl
3SGN089E	Industrial Banded - English (2 pg), vinyl
3SGN089F	Industrial Banded - French (2 pg), vinyl
3SGN090E	Impact - English (2 pg), vinyl
3SGN090F	Impact - French (2 pg), vinyl
3SGN254E	PRO - 7 Series Coloured, 1 pc - English (1 pg), vinyl
3SGN254F	PRO - 7 Series Coloured, 1 pc - French (1 pg), vinyl
3SGN255E	Industrial/Professional - English, vinyl
3SGN255F	Industrial/Professional - French, vinyl
3SGN270E	Industrial Banded - English (2 pg), vinyl
3SGN270F	Industrial Banded - French (2 pg), vinyl

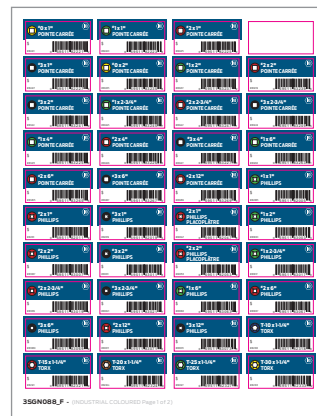
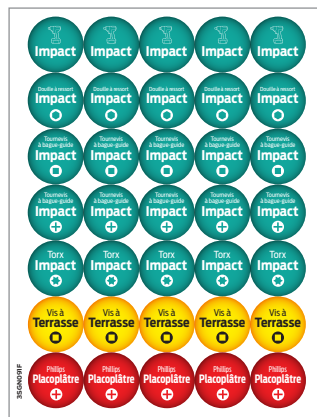
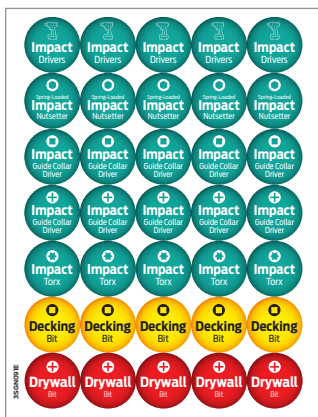

Bin Starbursts

Removable vinyl, 2 1/2" dia stickers, for use on all spinners.

Miscellaneous Bit Displays

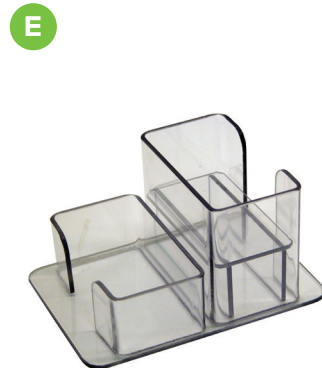

You will require 2 sets for each 3RCK200 spinner

A	3RCK200	Bit Clip Display
B	3RCK203	Top for Bit Clip Display (holds 4 handles)
C	3RCK201	Single Strip Bit Clip Display
D	3RCK205	Single Strip for 11pc Bit Clips
E	3RCK202	Base for Single Strips (holds 2 strips)
F	3SGN200E	Stickers - Screwdriver Bit Clips, set of 4 - English
	3SGN200F	Stickers - Screwdriver Bit Clips, set of 4 - French
G	3SGN201E	Stickers - Decking Bit Clips, set of 4 - English
	3SGN201F	Stickers - Decking Bit Clips, set of 4 - French
H	3SGN202E	Stickers - Impact Bit Clips, set of 4 - English
	3SGN202F	Stickers - Impact Bit Clips, set of 4 - French
I	3SGN205E	Stickers - Torsion Bit Clips, set of 4 - English
	3SGN205F	Stickers - Torsion Bit Clips, set of 4 - French

Miscellaneous Bit Displays <

3SGN065E & 3SGN065F - SS IND Impact & SD Bits, 7 1/4" x 5/16"
Designed to fit 3RCK237

3SGN067E & 3SGN067F - SS IND Impact & SD Bits, 10 3/4" x 5/16"
Designed to fit 3RCK235

Miscellaneous Bit Displays <

A



B



C



D

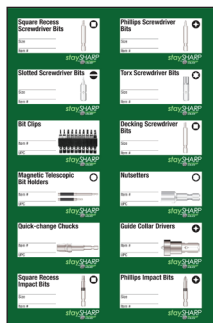

E

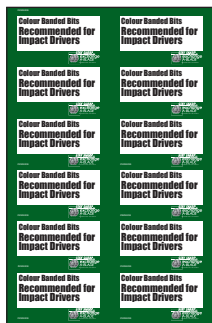

A	3RCK220	Metal rack for small globe jars, L 10.5" x W 14.5" x H 9" (holds 6 3RCK243)
B	3RCK243	Globe Bit Jar (Small)
C	3RCK244	Globe Bit Jar (Large)
C	3RCK245	Hexagonal Bit Jar
D	3SGN244E	Stickers - Screwdriver Bit Jar - English
D	3SGN244F	Stickers - Screwdriver Bit Jar - French
E	3SGN245	Stickers - Colour Banded Impact Bits - English
E	3SGN245F	Stickers - Colour Banded Impact Bits - French
F	3SGN068E	Header, 14" Impact & SD Bits, En
F	3SGN068F	Header, 14" Impact & SD Bits, Fr

F

STAY SHARP by EAB

tested INDUSTRIAL QUALITY EXTREME OUYE

IMPACT & SCREWDRIVER BITS

A full assortment of bits for every application
Impact • Decking • Drywall • Nutsetters • Bit holders

STAY SHARP by EAB

tested INDUSTRIAL QUALITY TRAVAILUX INTENSIFS

EMBOUS IMPACT • EMBOUS DE TOURNEVIS

Un assortiment complet d'embouts pour chaque application
Impact • Vis à terrasse • Douille • Porte-embout

3SGN068E & 3SGN068F - SS IND Impact & SD Bits, 14" x 4 1/2"

Miscellaneous Displays



Holds individual abrasive wheels on wire rack

A	3SGN405	Header - Taper Cut -Bilingual
B	3SGN141	Header - All Purpose - Bilingual
C	3RCK 600	Wire Rack - (holds 6 containers)
D	3RCK 601	Hook for individual abbrasive wheels

3RCK099	Abrasives Wire Rack
3POP099	Abrasive Wire Rack POP kit - Bilingual



ABRASIVES

The fastest, longest lasting wheels for cutting, grinding, sanding & polishing
Stainless Steel • Ferrous & Non-Ferrous Metals • Masonry



ABRASIFS

Les lames les plus rapides et de longues durées pour couper, meuler, poncer et polir
Acier Inoxydable • Métaux ferreux et non-ferreux • Maçonnerie



3SGN099E & 3SGN099F
SS PRO/IND SS Abrasives, 14" x 4"

A

EAB Exchangeable Saw Blades
Cashier Instructions

Identifying an EAB Exchangeable Blade
All new EAB exchangeable blades have a similar look, displaying the exchange message and Cash Code on the front, and Transaction Codes on the back.

Transaction Codes
Every EAB Saw Blade has two transaction codes.

UPC Purchase Code
A standard UPC bar code and number is used to track a new purchase and to identify other stock.

EAB Exchange Code
The Exchange Code is a 12-digit number beginning with 09929. It identifies the Cash Code (location) of the product and is engraved on the back of the blade. There is also a Cash Code on the back label. There is also a Cash Code on the back label.

Identifying d'une lame échangeable EAB
Toutes lames échangeables EAB ont une apparence semblable. Sur le devant, elles possèdent un message d'échange et le numéro de code à barre. Sur le dos, on trouve les codes de transaction.

Codes de transaction
Chaque lame échangeable EAB a deux codes de transaction.

Un code d'achat UPC
Un code-barres UPC standard avec numéros est utilisé pour identifier un achat et pour suivre le stock.

Code d'échange EAB
Le code d'échange est un numéro à 12 chiffres commençant par 09929. Il fait référence à la région de vente et est gravé sur le dos de la lame. Il est également présent sur l'étiquette au dos. Il y a aussi un code de code-barres.

Le code d'échange EAB est une référence à la région de vente et est gravé sur le dos de la lame. Il est également présent sur l'étiquette au dos. Il y a aussi un code de code-barres.

B

E

EAB Mandrel Exchange Chart
Tableau pour l'échange de mandrins

Decking Bits
Emboutis vis à tresse

F

C

EAB INDUSTRIAL Hole Saw Exchange Chart
Tableau pour l'échange de scies émetteuses INDUSTRIELLE

H

G

EAB STAY SHARP TORSION IMPACT BITS

H

EAB STAY SHARP EMBOUTIS DE TOURNEVIS TORSION

D

EAB M42 COBALT Hole Saw Exchange Chart
Tableau pour l'échange d'emporte-pièce au COBALT M42

A	3ADV042	Retail Sales Procedures - English
B	3ADV043	Retail Sales Procedures - French
C	3STN410	Cashier Exchange Card - Hole Saws - Bilingual
D	3STN415	Cashier Exchange Card - M42 Hole Saws - Bilingual
E	3STN411	Cashier Exchange Card - Mandrels & Recips - Bilingual
F	3STN414	Cashier Card - Impact/Decking EAB - Bilingual
G	3STN416E	Cashier Card - Complete Line Impact EAB - English
G	3STN416F	Cashier Card - Complete Line Impact EAB - French
H	3STN419E	Cashier Card - Torsion Impact - English
H	3STN419F	Cashier Card - Torsion Impact - French



	3BRO020 E	Blade Guide - English (50/pkg)
A	3BRO020 F	Blade Guide - French (50/pkg)
	3BRO020 S	Blade Guide - Spanish (50/pkg)
B	3BRO070	Diamond Blade Guide - Bilingual (50/pkg)
C	3BR0010ECO E	Router Bit Brochure - English (50/pkg)
	3BR0010 ECO F	Router Bit Brochure - French (50/pkg)
D	3STN220	Oops - Out of Stock Tags
E	3RCK055	Brochure Holder
F	3RCK055A	Screw kit for brochure holder (for mounting on Plywood)
G	3ADV041	1 1/2" EAB Binder (stock green temporary)
H	3ADV160 E	Product Catalogue - English
	3ADV160 F	Product Catalogue - French
I	3ADV100 E	Flash Drive Catalogue - English
J	3ADV100 F	Flash Drive Catalogue - French
K	3ADV272	EAB Pencil - 2015

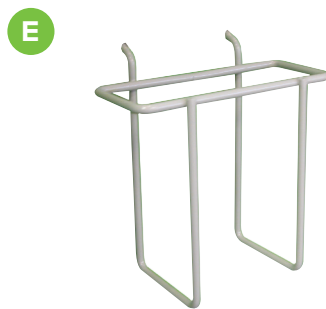

H **3ADV160 E** Product Catalogue (English)



3ADV160 F Product Catalogue (French)



3ADV272 EAB Pencil - 2015